

Product Catalogue

DC/DC Converters and Power Supplies

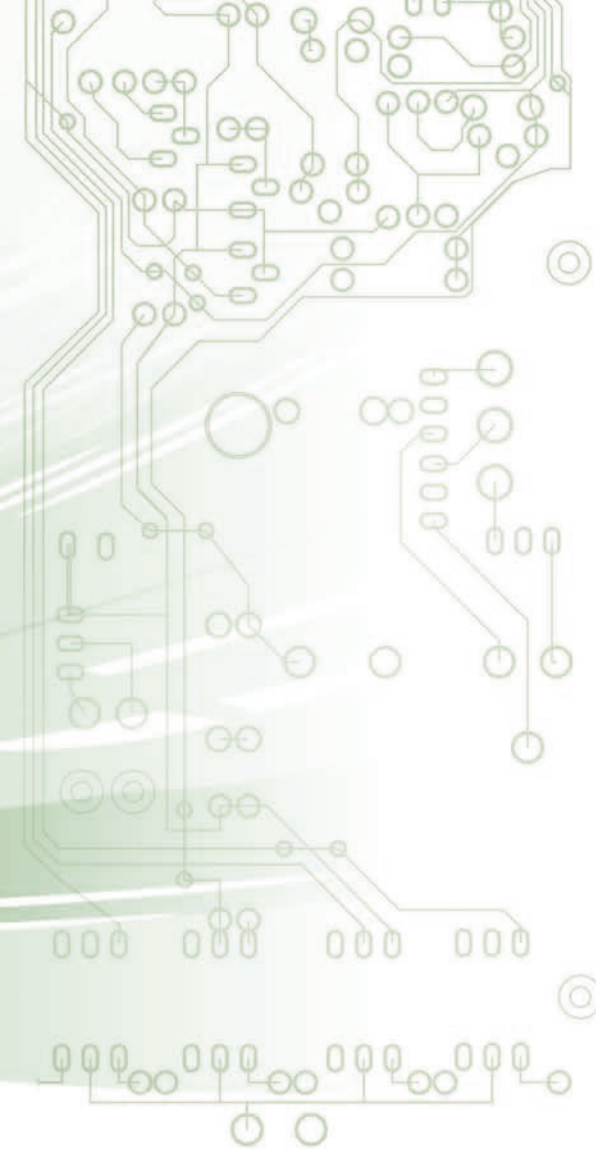

5V VTT



About Polyamp

Polyamp Power division specializes in design and production of mainly DC/DC converters and some compatible Power supplies. Our DC/DC converters are used in applications demanding high reliability in rough environments. Thru the years countless applications in sectors like Railway, Energy, Process control, Vehicles, Military, Radio and Telecom etc.

We provide our DC/DC converters to customers worldwide, with an established sales distributor network or directly where we do not have a distributor. Polyamp have three locations; the head office in Sollentuna suburb to Stockholm, Sweden. We have design and manufacturing of DC/DC converters in Åtvidaberg 230 km south of Stockholm and La Chaux-de-Fonds in Switzerland.

Our DC/DC converters have practical MTBF > 1 Million hours and our official warranty is two years. However in case we discover a fault due to workmanship the warranty is much longer than that. We have no dedicated service department as we have worked with quality assurance methods since end of 1980-ties. Our delivery accuracy is around 98% on time, in a day to day basis and delivers to just-in-time schemes. Our quality system is approved for Nuclear Plants Class 1E.

The Systems Division of Polyamp specializes in the design, manufacture and supply of Underwater Electromagnetic Signature Management and Control Systems for Worldwide application within the International Naval Industry / International Navy authorities.

The types of system supplied are Advanced Degaussing systems for surface and submarine naval vessels. Electromagnetic Mine Sweep supply, Underwater Electric Potential (UEP/ELFE) sensors and electromagnetic design and measurement systems.

The SWECADE software can predict and design coil systems, dimension Degaussing systems, control fixed and movable ranges, support signature analyze and document the fleet vessels signature history. Please read from page 30.

TABLE OF CONTENT

| | | | |
|--|-------|--|---------|
| About Polyamp | 2 | PSC-series 150 W DC/DC | 18 |
| Why Polyamp | 4 | PSC240-series 240 W DC/DC | 19 |
| Proven high reliability in rough environments..... | 5 | PM250-series 250 W DC/DC..... | 20 |
| General data | 6 | PM500-series 500 W DC/DC..... | 21 |
| Why a CE mark?..... | 7 | PU300-series 300 W DC/DC | 22 |
| Polyamp standard DC/DC products..... | 8 - 9 | PU500-series 500 W DC/DC | 23 |
| PSE100-series 100 W AC/DC..... | 10 | PSC600-series 800 W DC/DC..... | 24 |
| PSC-series 100-240 W AC/DC | 11 | PU1000-series 1000 W DC/DC..... | 25 |
| PM50-series 50 W DC/DC | 12 | PC1000-series 1000 W DC/DC..... | 26 |
| PM80-series 80 W DC/DC..... | 13 | PC2000-series 2000 W DC/DC | 27 |
| PM150-series 150 W DC/DC | 14 | Special models | 28 |
| PM240-series 240 W DC/DC..... | 15 | DC Power System Configurations..... | 29 |
| PSE100-series 100 W DC/DC | 16 | Magnetic and Electric Signature Control..... | 30 - 33 |
| PSE250-series 250 W DC/DC | 17 | About Polyamp | 34 |

Why Polyamp

Installed within 5 minutes

Mounting brackets are provided with the delivery. Wall, chassis, DIN-rail and 19" rack mounting methods are available depending on the model selected. Plug-in units for Euro format, 3HE & 6HE are also available.

Quality system

100% reliable products assured. We have a proven record of 98% on time delivery on a day base. We are what some customer call a 100% supplier, 100% quality and 100% on time.

MTBF & Life expectancy

Our design is carefully made by our experienced design team. This leads to very high practical MTBF and long life expectancy of our converters. Some units have predicted MTBF > 3 Million hours and most products will live 15-25 years.

Integrated mechanics and electronics

We start a design with the mechanical considerations before integrating the electronics. This ensure very good cooling of all components. Low working temperature result in long life.

Products are CE marked

as an apparatus in respect of Safety, EMC and also RoHS.

Input well filtered

We use well dimensioned EMC filters meeting low emission and high immunity requirements.

Output well filtered

We have well designed EMC filters on the output, meeting low emissions and high immunity requirements. The output can therefore be used for voltage distribution without any additional EMC filters. Most competitors have no EMC filters on the output at all.

We specify working temp. without derating

-25° to +55°C is standard for our modules and -25° to +70°C for our Euro cassettes.

Run a Polyamp at full load continuously

We have about 10% margin on the rated output power. Not always the case with competitors.

"Gold" colour not black

The gold colour of our cases is chosen not only for its look. The thermal radiation at operating temperature is the same as black, but it absorbs much less heat from other equipments. Low working temperature = Long life expectancy.

Aluminum cover

Gives good cooling and also easy to recycle. We have an environmental program that minimize unfriendly materials and workmanship. With small modifications it also permits to meet the EN 45545 Fire and Smoke standard.

Convection cooled

Our designs are made for convection cooling. Self standing units with no need for forced ventilation. Can be mounted in any direction.

No ventilation holes

Minimize the risk of dust entering into the unit, which is important in industrial and mobile applications. Can be mounted in any direction.

Transport packing

We ship all units in single boxes or in cleaver card box frames. Safely protecting the product during transportation. As there is only one material in the box it's easy to recycle. Meets Grüne punkt .



PM500-series

Proven high reliability in rough environments

- On-board trains
- Industry, Process control
- Power plants, including Nuclear
- Vehicles: Electric & Military
- Telecom & Radiocom
- Naval, Off-shore platforms

DC/DC converters functions

- Voltage transformer
- Galvanic separation
- Polarity changer
- Stabilizer
- Substitute to batteries
- EMC Filter
- Combination of above



General data

DC/DC converters from Polyamp are a free standing unit which will be installed within 5 minutes. The aluminum cover gives good cooling and also easy to recycle. We have an environmental program that minimize unfriendly materials and workmanship. Most of Polyamps converters are design for convection cooling. The in- and output have well designed EMC-filters, meeting low emissions and high immunity requirements.

Input protection

In general we don't supply our DC/DC converters with fuses because the fuse specifications vary between applications on dc voltages and another reason is that on DC distribution networks the fuse to the DC/DC converters should be at the distribution point, to protect the cables from short circuits. All models have a parallel or series diode to protect against input reverse voltages.

Inrush current

On the input side there is an inrush current to charge the input capacitor. The level of inrush current depends on the systems impedance and voltage. Some models has inrush current limit circuits with NTC resistor and it can be optional on some. The PSC600-, PU1000- and PC2000-series have an active inrush current limit. Basically we are reluctant to use NTC as inrush-current limit. In many DC/DC converter applications they are connected in redundancy or in by-pass to an AC/DC power supply. In such cases, the converter will not be able to supply enough current until the NTC warms up. All converters from Polyamp have a softstart which will charge the output capacitors in a controlled way during start up.

Parallel connection for more power

By connecting two or more units in parallel you can achieve higher power systems. As Polyamp can supply converters up to 2000 W it's usually suitable for very large systems.

Parallel connection for redundancy

Each converter is specified to carry the whole load. The converters must have series diode and output alarms to provide fault indication in case of failure. The PU1000- and PC2000-series have an active current sharing control. The PSE and PSC has a passive balancing resistor that provide current sharing with option CR.

MTBF

The statistical figure MTBF can be put at more than 1 Million hours at 40°C ambient temperature. This is based upon our historical data. However, the MTBF should not be confused with life expectancy. We design our converters for long life expectancy. As a result we get good practical MTBF values. Calculated MTBF values might be lower.

How to load / How to cool

Our converters are specified and tested to work at a full ambient temperature range of -25 to +55°C or +70°C at 100% load. Continuous operation at high ambient temperatures reduces the life expectancy of a unit. It's very efficient to arrange a small airflow around the converters. A 10°C lower ambient temperature will basically doubles the life expectancy of the unit. A general feature of a Polyamp converter is that it's relatively cool at full load. Consult Polyamp on general thermal management questions for your application.

Ambient temperature and output power

Our standard operating temperature range is -25 to +55°C with 100% load. It means that the temperature around the case has that temperature. Our DC/DC converters has relatively large coolers which provides some thermal after lag. Therefore temporary temperature peaks outside the range can be accepted. E.g. the railway standards EN50155 demands 15°C increase during 10 minutes.

Operating temperature up to +70°C can be achieved with derating and with forced air cooling up to 85°C. See below figure. The PSC and PSE series are specified up to +70°C without derating.

Please note that the life expectancy of a power supply unit is very linked to the ambient temperature. A rule of thumb is that 8-10°C temperature increase halves the life expectancy. In reality this is valid from about 30-40°C ambient temperature. -40°C is optional as we need to test that the unit starts at this temperature.

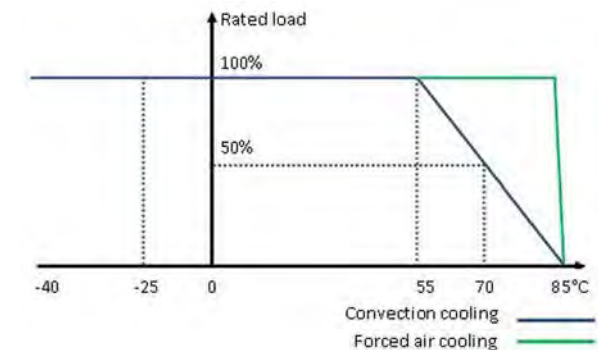

Why a CE mark?

Product responsibility is always with the manufacturer. To help achieving a safe product a number of EU directives have been issued. Using these directives and related harmonized standards the manufacturer must create a technical construction file (TCF), which will point to a number of requirements that have to be met to achieve product safety.

A CE-mark indicates that the requirements have been investigated and the product found to be safe for the intended use. Together with the product documentation we provide a CE- declaration that not only specify to which Directives this product comply to but for the EMC directive also indicates the performance on both input and output.

EMC

The reason is that there are several Directives that involve EMC and the EMC directive itself generated many Product standards for different sectors. However the same Basic standards are used to measure the EMC performance, except for military applications. Our performance covers most of them e.g. Telecom, Power industry, Railways, Process industry etc.

Below is listed some Directives that have EMC requirements:

- EMC directive 2004/108/EC,
- RTTED directive 1999/5/EC (Radio and telecom)
- HSR directive 96/48/EC and CONRAIL directive 2001/16/EC. (Railways)
- Marine equipment 2002/84/EC

Safety

The Low voltage directive, 2006/95/EC has priority over the 2006/42/EC Machinery safety, for electric and electronic products. The voltage limit of 50 Va.c. or 75 Vd.c, which in fact means that DC/DC converters using voltages below that shall not refer to safety in the CE mark. However the revised directive accepts a CE mark on lower voltages if the product is made according to a harmonized safety standard, e.g. EN 60950.

Environmental

The RoHS 2011/65/EC directive is now also included in the New approach principles and require a CE mark. All our components and materials are RoHS compliant, however we still have 2 soldering lines, one with Lead free and one with Lead as parts of the industry do not want lead free soldering at the moment. The open scope of the RoHS directive stipulates to phase out lead 2019, however some application are excluded.

The conclusion is that a Polyamp CE mark means EMC and LVD directive (also below 75 Vd.c.) and the RoHS directive.

Other Directives

The REACH 2006/21/EC directive has many aspects around substances. For most electronic manufacturers it is today and in future the list of reportable chemicals, that get successively longer, which causes problems. Polyamp has done a material analyze to screen critical areas.

The difference between the RoHS directive and REACH is that RoHS specify from homogeneous materials thus all single components, while the REACH consensus at the moment is the LRU level (Least Replaceable Unit) even the authorities has "substance is always a substance" attitude. As our units have a sturdy integrated mechanics, typically 80% of the weights of a unit consist of metals, mostly Aluminum, Copper and Iron (Ferrites).

The current WEEE 2002/96/EC directive does not affect us as our products are included in other equipment. However the future WEEE (2012) directive might change that.

The EuP directive was amended to Directive (2009/125/EC). The most important amendment concerns the Directive's scope, which has been extended from "energy-using" to so-called "energy-related" products. However this directive regards Eco design in general. Initial life cycle analyses (LCA) resulted in a focus on "in use efficiency" as it was the main environmental factor. Currently there are forces that what to challenge the used LCA model and reintroduce the original idea "from the mine, manufacturing, in-use to recycling" analyze.



Polyamp standard DC/DC products

Our DC/DC converter program covers a wide range of dc inputs from 10 V up to 750 Vd.c. This page helps you select the right DC/DC converter family depending of what demands you have. Polyamp guarantee full performance within the specified input range, which means 105% load capacity, 110% output voltage level at max rated operational temperature. Our voltages ranges are selected to meet international market demands.

12 V input

Is used mainly in car related applications or small mobile systems or in back-up systems. 12 V input voltage is handled by the A input voltage range 10-30 V or an input range coded 12 (11-16V).

| Input range | Family code |
|----------------------|------------------------------------|
| A = 10 - 30 Vd.c. | PM50, PSE100, PSC150, PM150, PU300 |
| 12 = 11 - 16Vd.c.(*) | PM250, PU300 12/27 |

A common question is if we can handle cranking down to 6 V. In general the converter switch off at <9.5 V. The PM50A input handles 6 V with derating, consult the datasheet for more information.

Applications around 12 V car systems are drowned by "cheap and dirty" converters as it is directed to consumers that usually do not use sensitive applications. A cigarette outlet supplied converter from good brand laptop manufacturer can kill a whole Police or Ambulance EMC environment. Polyamp deliver to Police and Ambulances, modified vehicles used around Swedish UN troops worldwide.

24 - 28 V input

Is used in many applications. Use the B input code 20-60 V or the 24 input code 20-32 V.

| Input range | Family code |
|-------------------------|---|
| B = 20 - 60 Vd.c. | PM50, PSC150, PM150, PU300, PU600 |
| B = 20 - 72 Vd.c. | PSE100 |
| 24 = 18 - 32 Vd.c. | PM80, PM240, PSC240, PU500, PU1000 |
| 24 = 20 - 32 Vd.c. (*) | PSE200, PSE250, PM250, PC1000 |
| 24T = 14.4 - 33.6 Vd.c. | For train EN 50155/IEC 60571 and forklifts, on demand |
| 24T = 12 - 40 Vd.c. | For some train markets, on demand |
| 28T = 16 - 40 Vd.c. | MIL-STD 1275-D (28V) / ISO 7637-2 (24V), on demand |

An alternative in case you have cranking voltages use A input, see 12 V input. An A input version has always slightly lower efficiency than above mentioned inputs.

36 V input

Is today mostly used in train applications and on the North American markets. Use the B input (20-60 V) or ask for a specific 36 input range. The 36 input code it is not in our standard input range but can be made on demand. For train or mobile applications a standard B-input range covers EN50155, IEC60571 train standards.

Input range

B = 20 - 60 Vd.c.

B = 20 - 72 Vd.c.

36 = 28 - 50 Vd.c.

36 = 30 - 50 Vd.c. (*)

36T = 21.6 - 50.4 Vd.c.

36T = 18 - 60 Vd.c.

Family codes

PM50, PSC150, PM150, PU300, PU600

PSE100

PM80, PM240, PSC240, PU500, PU1000

PSE200, PSE250, PM250, PC1000, PC1400

For train EN 50155/IEC 60571 and forklifts, on demand

For some train markets, on demand

48 V input

Is used mainly in telecom related applications, where low emission is required. We have EN50022 level B on all such inputs. Use the B input code or 48. For EN50155, IEC60571 train standards use input code 48T with this the output power can be derated.

Input range

B = 20 - 60 Vd.c.

B = 20 - 72 Vd.c.

48 = 38 - 60 Vd.c.

48 = 41 - 60 Vd.c. (*)

48T = 28.8 - 68 Vd.c.

48T = 24 - 40 Vd.c.

Family codes

PM50, PSC150, PM150, PU300, PU600

PSE100

PM80, PM240, PSC240, PU500, PU1000

PSE200, PSE250, PM250, PM500, PC1000, PC1400, PC2000

For train EN 50155/IEC 60571 and forklifts, on demand

For some train markets, on demand

60 - 96 V input

60 Vd.c. is used mainly in telecom applications on certain markets. We can make special inputs for 48-60 V input with 38-72 V input. 72 Vd.c. is used mainly in trains. Use our C input range or 72T. 96 Vd.c. is not very common these days, it has mainly been used in large fork-lifts. Use our C input range and require a series diode on the input.

| Input range | Family codes |
|--------------------------|--|
| B = 20 - 72 Vd.c. | PSE100 |
| C = 50 - 150 Vd.c. | PM50, PSE100, PSC150, PM150, PU300, PU600 |
| 72 = 60 - 100 Vd.c. | On demand |
| 72T = 43.2 - 100.8 Vd.c. | For train EN50155/IEC 60571 and forklifts, on demand |

110 V input

Is used mainly on trains, in power plants and sub-station applications. High immunity levels are required. Use the D input (90-270 V) or 110 (93-150 V). For EN50155, IEC60571 train standards use our C-input (50-150 V) or 110T (66 – 154 V).

| Input range | Family codes |
|--------------------------|--|
| C = 50 - 150 Vd.c. | PM50, PSE100, PSC150, PM150, PU300, PU600 |
| D = 90 - 270 Vd.c. | PM50, PSE100, PSC150, PM150, PU300, PU600 |
| 110 = 88 - 150 Vd.c. | PM80, PM240, PSC240, PU500, PU1000 |
| 110 = 93 - 150 Vd.c. (*) | PSE200, PSE250, PM250, PM500 PC1000, PC1400, PC2000 |
| 110T = 66 – 154 Vd.c. | For train EN 50155/IEC60571 and forklifts, on demand |

220 - 250 V input

Is used mainly in power plants and sub-station applications. High immunity levels are required. Use the D input code or 220. The 250 V battery is not very common but can only be used with 220 inputs. Hybrid cars and submarines uses similar voltages, please contact us.

| Input range | Family codes |
|---------------------------|---|
| D = 90 - 270 Vd.c. | PM50, PSE100, PSC150, PM150, PU300, PU600 |
| 220 = 175 - 300 Vd.c. | PM80, PM240, PSC240, PU500, PU1000 |
| 220 = 187 - 300 Vd.c. (*) | PSE200, PSE250, PM250, PM500 PC1000, PC1400, PC2000 |

>300 V input

Are used mainly in power plants, oil platforms, hybrid / electric car applications or in ROV and submarines. There are also applications for 600/750 Vd.c. in Traction & Metro applications according to IEC 60850. All those are special executions. The standard models we have are:

| Input range | Family codes |
|-----------------------|----------------|
| E = 260 - 500 Vd.c. | PSC150 |
| 440 = 350 - 500 Vd.c. | PSC240 |
| 440 = 300 - 600 Vd.c. | PU1000 |
| 600 = 400 - 900 Vd.c. | PSD200 600/200 |

(*) Rated input voltage with max rating and temperature. The input accept < -35% of nominal input before switching of the converter. The output can drop to 95% of nominal output.

Input voltage ranges

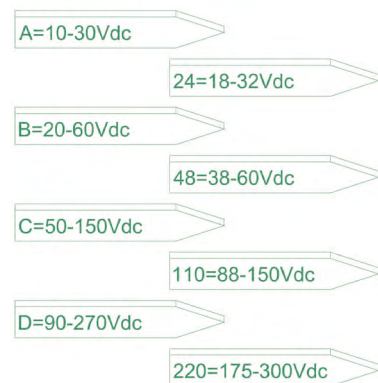

Power

30-2000W

Output

5V
12V
15V
24V
28V
36V
48V
60V
110V
125V



PSE100-series 100 W AC/DC

FEATURES

85 to 264 Va.c. input
 5 to 48 V output
 Logic alarm
 Operating temp. -25 to +70°C,
 without derating
 Tropical coating
 Euroformat 8TE, 3HE
 DIN-rail, wall mounting or
 19" sub rack

EMC & SAFETY

EN60950 class I
 EN61000-6-2, Immunity
 EN61000-6-3, Emission
 EN/IEC61000-4-4, 4 kV
 EN/IEC61000-4-5 level 2 & 3
 EN50121-3-2 & EN50121-4
 IEC62236-3-2 & IEC62236-4

OPTIONS

Series diode on output
 Train inputs
 Alarm relay with selectable NO/NC function

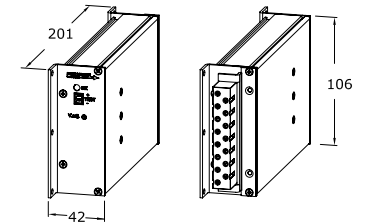
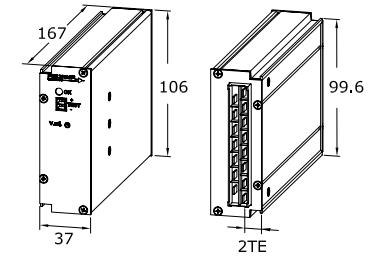

DIN or wall mounting
 Model with N (standard)

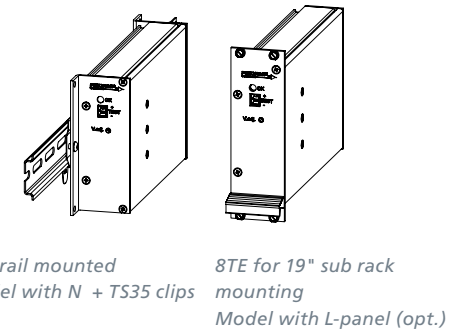

DIN-rail mounted
 Model with N + TS35 clips
 8TE for 19" sub rack
 mounting
 Model with L-panel (opt.)

| OUTPUT | | | AC INPUT | | |
|---------|---------------------|-------|----------------|----------------|-----------------|
| Voltage | Current | Power | 85 - 264 Va.c. | 85 - 135 Va.c. | 176 - 264 Va.c. |
| 5 V | 12.0 A ¹ | 60 W | PSE60ACW5 | | |
| 5 V | 20.0 A ¹ | 100 W | | PSE100ACR5 | PSE100AC5 |
| 13.2 V | 4.50 A | 60 W | PSE60ACW13.2 | | |
| 13.2 V | 7.60 A | 100 W | | PSE100ACR13.2 | PSE100AC13.2 |
| 15 V | 4.00 A | 60 W | PSE60ACW15 | | |
| 15 V | 6.70 A | 100 W | | PSE100ACR15 | PSE100AC15 |
| 24 V | 2.50 A | 60 W | PSE60ACW24 | | |
| 24 V | 4.20 A | 100 W | | PSE100ACR24 | PSE100AC24 |
| 48 V | 1.30 A | 60 W | PSE60ACW48 | | |
| 48 V | 2.10 A | 100 W | | PSE100ACR48 | PSE100AC48 |

1) -25 to +55°C 100% load, 70°C at 75% load. With extra cooler, see picture at next page, the rating is 100% load at 70°C.

The tables indicates the standard models.
 Other input and output combinations on demand.



PSC-series 100-240 W AC/DC

FEATURES

85 to 264 Va.c. input
 5 to 110 V output
 Up to three outputs
 Operating temp. -25 to +70°C,
 without derating
 Tropical coating
 Euroformat 10TE, 12TE 3HE
 DIN-rail, wall mounting or
 19" sub rack

EMC & SAFETY

EN60950 class I
 EN61000-6-2, Immunity
 EN61000-6-3, Emission
 EN/IEC61000-4-4, 4 kV
 EN/IEC61000-4-5 level 2 & 3
 EN50121-3-2 & EN50121-4
 IEC62236-3-2 & IEC62236-4

OPTIONS

Series diode on output
 Train inputs
 Alarm relay with selectable NO/NC function
 Mechanical features, see page 19

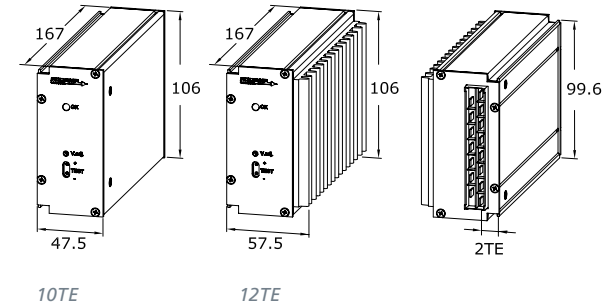

| SINGLE OUTPUT | | | DUAL OUTPUTS | | | | | | TRIPLE OUTPUTS | | | | | |
|---------------|--------|-------|---------------|---------------|-------------------|--------|-------------|---------------|----------------|--------------|--------|-------------|--|--|
| Output | | Power | Master output | | Slave output | | Power | Master output | | Slave output | | Power | | |
| 5 V | 30.0 A | 150 W | 5 V | 17.0 - 25.0 A | 12 V | 1.20 A | 100 - 150 W | 5 V | 14 - 23.0 A | ±12 V | 1.20 A | 100 - 150 W | | |
| 12 V | 12.5 A | 150 W | 5 V | 17.0 - 25.0 A | 15 V | 1.20 A | 100 - 150 W | 5 V | 14 - 23.0 A | ±15 V | 1.20 A | 100 - 150 W | | |
| 13.6 V | 11.0 A | 150 W | 12 V | 7.30 - 11.0 A | 5 V ¹⁾ | 2.50 A | 100 - 150 W | | | | | | | |
| 15 V | 16.0 A | 240 W | 12 V | 7.00 - 11.0 A | 12 V | 1.20 A | 100 - 150 W | | | | | | | |
| 24 V | 10.0 A | 240 W | 15 V | 5.50 - 9.00 A | 12 V | 1.20 A | 100 - 150 W | | | | | | | |
| 48 V | 5.00 A | 240 W | 24 V | 3.00 - 5.00 A | 24 V | 1.20 A | 100 - 150 W | | | | | | | |
| 110 V | 2.20 A | 240 W | | | | | | | | | | | | |

¹⁾ Common zero with master output.

The above table indicates the standard models. Other input and output combinations on demand.

| AC INPUTS | | | |
|------------|-------------|---------------------|-------------|
| Input code | Input range | Nominal input | Frequency |
| ACR | 85 - 135 V | 100, 110 Va.c. | 48 - 420 Hz |
| AC | 176 - 264 V | 220, 230, 240 Va.c. | 48 - 420 Hz |
| ACW | 85 - 264 V | 110, 127, 230 Va.c. | 48 - 420 Hz |

| POWER RANGES | | |
|--------------|-------|-----------|
| Modell | Watt | Dimension |
| PSC100 | 100 W | 10TE |
| PSC150 | 150 W | 12TE |
| PSC240 | 240 W | 12TE |

PM50-series 50 W DC/DC



FEATURES

Wide input voltage range
 10 to 270 V input
 12 to 132 V output
 1 or 2 outputs
 Low ripple outputs
 Operating temp. -25 to +55°C,
 without derating
 DIN-rail or wall mounting
 Tropical coating

EMC & SAFETY

EN60950 class I
 EN61000-6-2, Immunity
 EN61000-6-3, Emission
 EN/IEC61000-4-4, 4 kV
 EN/IEC61000-4-5 level 2 & 3
 EN50121-3-2 & EN50121-4
 IEC62236-3-2 & IEC62236-4

OPTIONS

Mounting bracket L60-1

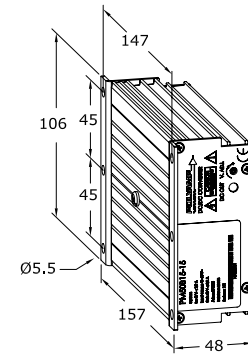

| OUTPUT | | INPUT | | OUTPUT | | INPUT | | | OUTPUT | |
|---------|------------|---------|-------|------------|------------|------------|---------|-------|---------|-------|
| Voltage | 10 - 30 V | Current | Power | 20 - 60 V | 50 - 150 V | 90 - 270 V | Current | Power | Current | Power |
| 12 V | PM50A15-15 | 2.67 A | 32 W | PM50B15-15 | PM50C15-15 | PM50D15-15 | 3.34 A | 40 W | | |
| 15 V | PM50A15-15 | 2.67 A | 40 W | PM50B15-15 | PM50C15-15 | PM50D15-15 | 3.34 A | 50 W | | |
| 18 V | PM50A18-18 | 2.60 A | 47 W | PM50B18-18 | | | 3.20 A | 57 W | | |
| 18 V | | | | | PM50C18-18 | | 2.78 A | 50 W | | |
| 24 V | PM50A15-15 | 1.34 A | 32 W | PM50B15-15 | PM50C15-15 | PM50D15-15 | 1.67 A | 40 W | | |
| 28 V | PM50A15-15 | 1.34 A | 37 W | PM50B15-15 | PM50C15-15 | PM50D15-15 | 1.67 A | 47 W | | |
| 36 V | PM50A18-18 | 1.30 A | 47 W | PM50B18-18 | | | 1.60 A | 57 W | | |
| 36 V | | | | | PM50C18-18 | | 1.39 A | 50 W | | |
| 60 V | PM50A60-60 | 0.67 A | 40 W | PM50B60-60 | PM50C60-60 | PM50D60-60 | 0.84 A | 50 W | | |
| 110 V | PM50A60-60 | 0.34 A | 37 W | PM50B60-60 | PM50C60-60 | PM50D60-60 | 0.42 A | 46 W | | |

| OUTPUT | | INPUT | | OUTPUT | | INPUT | | | OUTPUT | |
|----------|------------|---------|-------|------------|------------|------------|---------|-------|---------|-------|
| Voltage | 10 - 30 V | Current | Power | 20 - 60 V | 50 - 150 V | 90 - 270 V | Current | Power | Current | Power |
| 2 x 12 V | PM50A15-15 | 1.34 A | 32 W | PM50B15-15 | PM50C15-15 | PM50D15-15 | 1.67 A | 40 W | | |
| 2 x 15 V | PM50A15-15 | 1.34 A | 40 W | PM50B15-15 | PM50C15-15 | PM50D15-15 | 1.67 A | 50 W | | |
| 2 x 18 V | PM50A18-18 | 1.30 A | 47 W | PM50B18-18 | | | 1.60 A | 57 W | | |
| 2 x 18 V | | | | | PM50C18-18 | | 1.39 A | 50 W | | |
| 2 x 60 V | PM50A60-60 | 0.34 A | 40 W | PM50B60-60 | PM50C60-60 | PM50D60-60 | 0.42 A | 50 W | | |

PM50 has 2 insulated outputs 500 Vd.c. that can be connected as separate voltages, in parallel, in series or as ±voltage.
 The above tables indicates the standard models. Other input and output combinations on demand.

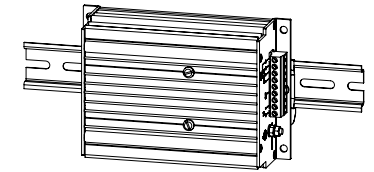

PM50/80 DIN-rail mounted (standard)

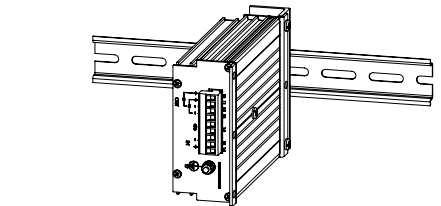
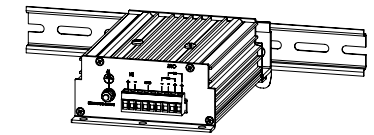

PM50/80 DIN-rail mounted L60-1 (option)

PM80-series 80 W DC/DC



FEATURES

18 to 300 V input
 24 to 72 V output
 1 or 2 outputs
 Low ripple outputs
 Operating temp. -25 to +55°C,
 without derating
 DIN-rail or wall mounting
 Tropical coating

EMC & SAFETY

EN60950 class I
 EN61000-6-2, Immunity
 EN61000-6-3, Emission
 EN/IEC61000-4-4, 4 kV
 EN/IEC61000-4-5 level 2 & 3
 EN50121-3-2 & EN50121-4
 IEC62236-3-2 & IEC62236-4

OPTIONS

Mounting bracket L60-1

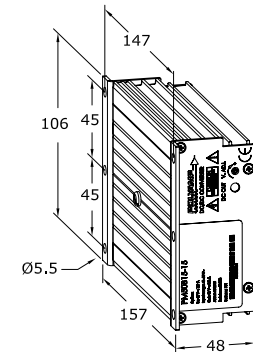

| SINGLE OUTPUT | | | INPUT | | | |
|---------------|---------|-------|---------------|---------------|----------------|----------------|
| Voltage | Current | Power | 18 - 32 V | 40 - 60 V | 88 - 150 V | 175 - 300 V |
| 24 V | 2.50 A | 60 W | PM80 24/24-24 | | | |
| 24 V | 3.34 A | 80 W | | PM80 48/24-24 | PM80 110/24-24 | PM80 220/24-24 |
| 36 V | 1.68 A | 60 W | PM80 24/36-36 | | | |
| 36 V | 2.24 A | 80 W | | PM80 48/36-36 | PM80 110/36-36 | PM80 220/36-36 |
| 48 V | 1.25 A | 60 W | PM80 24/24-24 | | | |
| 48 V | 1.67 A | 80 W | | PM80 48/24-24 | PM80 110/24-24 | PM80 220/24-24 |
| 72 V | 0.84 A | 60 W | PM80 24/36-36 | | | |
| 72 V | 1.12 A | 80 W | | PM80 48/36-36 | PM80 110/36-36 | PM80 220/36-36 |

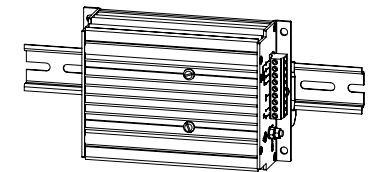

PM50/80 DIN-rail mounted (standard)

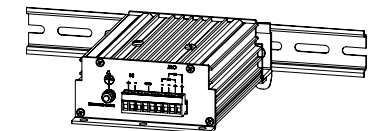

PM50/80 DIN-rail mounted L60-1 (option)

| DUAL OUTPUTS | | | | | INPUT | | | |
|--------------|---------|---------|---------|-------|---------------|---------------|----------------|----------------|
| Voltage | Current | Voltage | Current | Power | 18 - 32 V | 40 - 60 V | 88 - 150 V | 175 - 300 V |
| 24 V | 1.25 A | 24 V | 1.25 A | 60 W | PM80 24/24-24 | | | |
| 24 V | 1.67 A | 24 V | 1.67 A | 80 W | | PM80 48/24-24 | PM80 110/24-24 | PM80 220/24-24 |
| 36 V | 0.84 A | 36 V | 0.84 A | 60 W | PM80 24/36-36 | | | |
| 36 V | 1.12 A | 36 V | 1.12 A | 80 W | | PM80 48/36-36 | PM80 110/36-36 | PM80 220/36-36 |

PM80 has 2 insulated outputs 500 Vd.c. that can be connected as separate voltages, in parallel, in series or as \pm voltage.
 The above tables indicates the standard models. Other input and output combinations on demand.

PM150-series 150 W DC/DC

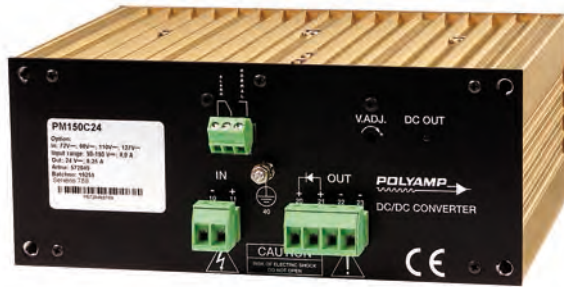

FEATURES

Wide input voltage range
 10 to 270 V input
 12 to 48 V output
 2.5 kVa.c. isolation output/case
 Over voltage protection
 Output voltage alarm
 Series diode on output
 Operating temp. -25 to +55°C,
 without derating
 DIN-rail, wall mounting or
 19" rack

EMC & SAFETY

EN60950 class I
 EN61000-6-2, Immunity
 EN61000-6-3, Emission
 EN/IEC61000-4-4, 4 kV
 EN/IEC61000-4-5 level 2 & 3
 EN50121-3-2 & EN50121-4
 IEC62236-3-2 & IEC62236-4

OPTIONS

Train inputs
 Tropical coating
 Mechanical features, see page 14-15

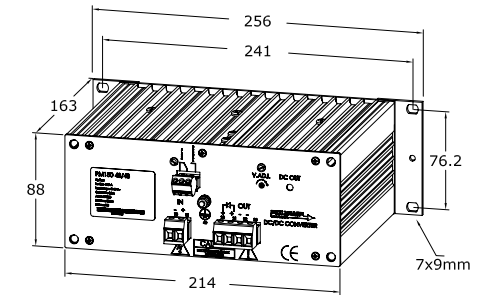

PM150/240 wallmounted. Brackets PL88-1 (standard)

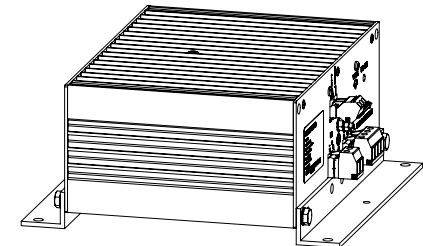

PM150/240 wallmounted. Brackets PL214-1 (optional)

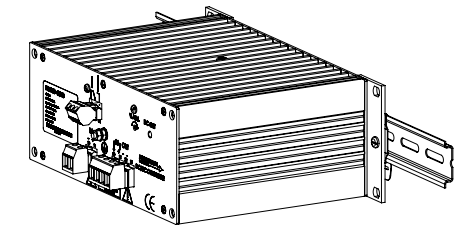

PM150/240 DIN- or wall-mounted. Standard brackets + TS35 clips

| OUTPUT | | | INPUT | | | |
|---------|---------|-------|------------|------------|------------|------------|
| Voltage | Current | Power | 10 - 30 V | 20 - 60 V | 50 - 150 V | 90 - 270 V |
| 12 V | 10.0 A | 120 W | PM150A12 | | | |
| 12 V | 12.5 A | 150 W | | PM150B12 | PM150C12 | PM150D12 |
| 13.8 V | 8.70 A | 120 W | PM150A13.8 | | | |
| 13.8 V | 10.9 A | 150 W | | PM150B13.8 | PM150C13.8 | PM150D13.8 |
| 15 V | 8.00 A | 120 W | PM150A15 | | | |
| 15 V | 10.0 A | 150 W | | PM150B15 | PM150C15 | PM150D15 |
| 24 V | 5.00 A | 120 W | PM150A24 | | | |
| 24 V | 6.25 A | 150 W | | PM150B24 | PM150C24 | PM150D24 |
| 28 V | 5.36 A | 150 W | | PM150B28 | PM150C28 | PM150D28 |
| 36 V | 4.17 A | 150 W | | PM150B36 | | |
| 48 V | 2.50 A | 120 W | PM150A48 | | | |
| 48 V | 3.13 A | 150 W | | PM150B48 | PM150C48 | PM150D48 |

The above table indicates the standard models. Other input and output combinations on demand.

PM240-series 240 W DC/DC

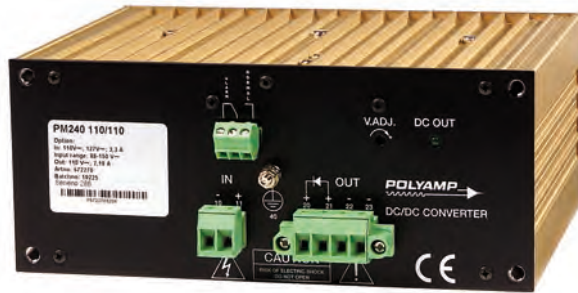

FEATURES

18 to 300 V input
 24 to 110 V output
 2.5 kVa.c. isolation output/case
 Over voltage protection
 Output voltage alarm
 Series diode on output
 Operating temp. -25 to +55°C,
 without derating
 DIN-rail, wall mounting or
 19" rack

EMC & SAFETY

EN60950 class I
 EN61000-6-2, Immunity
 EN61000-6-3, Emission
 EN/IEC61000-4-4, 4 kV
 EN/IEC61000-4-5 level 2 & 3
 EN50121-3-2 & EN50121-4
 IEC62236-3-2 & IEC62236-4

OPTIONS

Train inputs
 Tropical coating
 Mechanical features, see page 14-15

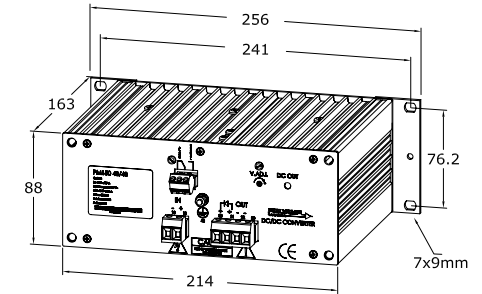

PM150/240 wallmounted. Brackets PL88-1 (standard)

| OUTPUT | | | INPUT | | | |
|---------|---------|-------|--------------|--------------|---------------|---------------|
| Voltage | Current | Power | 18 - 32 V | 38 - 60 V | 88 - 150 V | 175 - 300 V |
| 24 V | 9.00 A | 216 W | PM240 24/24 | | | |
| 24 V | 10.0 A | 240 W | | PM240 48/24 | PM240 110/24 | PM240 220/24 |
| 36 V | 6.67 A | 240 W | | PM240 48/36 | | |
| 48 V | 4.50 A | 216 W | PM240 24/48 | | | |
| 48 V | 5.00 A | 240 W | | PM240 48/48 | PM240 110/48 | PM240 220/48 |
| 60 V | 3.60 A | 216 W | PM240 24/60 | | | |
| 60 V | 4.00 A | 240 W | | PM240 48/60 | PM240 110/60 | PM240 220/60 |
| 110 V | 1.97 A | 216 W | PM240 24/110 | | | |
| 110 V | 2.19 A | 240 W | | PM240 48/110 | PM240 110/110 | PM240 220/110 |

The above table indicates the standard models. Other input and output combinations on demand.

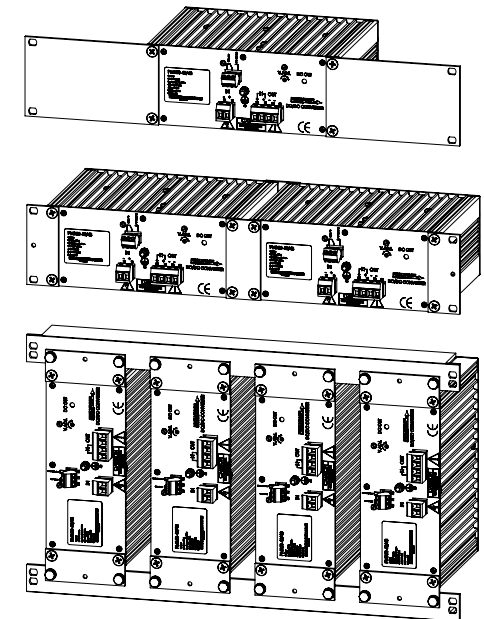

PM150/240 19" rack.

- 1) Brackets PL88-3 (optional)
- 2) Standard brackets + PL88-2 (optional)
- 3) Standard brackets + L480-2 (optional)



PSE100-series 100 W DC/DC

FEATURES

10 to 270 Vd.c. input
 5 to 48 Vd.c. output
 Logic alarm
 Operating temp. -25 to +70°C,
 without derating
 Tropical coating
 Euroformat 8TE, 3HE
 DIN-rail, wall mounting or
 19" subrack

EMC & SAFETY

EN60950 class I
 EN61000-6-2, Immunity
 EN61000-6-3, Emission
 EN/IEC61000-4-4, 4 kV
 EN/IEC61000-4-5 level 2 & 3
 EN50121-3-2 & EN50121-4
 IEC62236-3-2 & IEC62236-4

OPTIONS

Series diode on output
 Train inputs
 Alarm relay with selectable NO/NC function

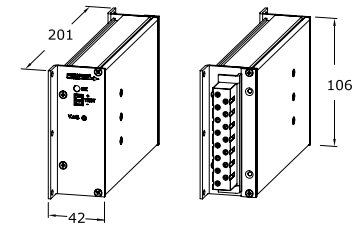
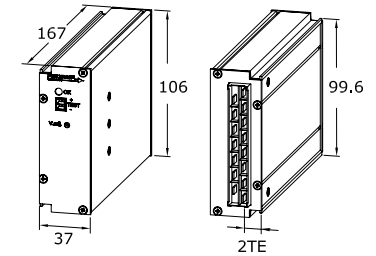

DIN or wall mounting
 Model with N (standard)

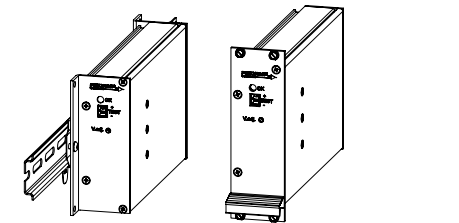

DIN-rail mounted
 Model with N + TS35 clips
 19" subrack mounting
 Model with L-panel (opt.)

| OUTPUT | | | DC INPUT | | | |
|---------|---------------------|-------|-------------|-------------|-------------|-------------|
| Voltage | Current | Power | 10 - 30 V | 20 - 72 V | 50 - 150 V | 90 - 270 V |
| 5 V | 20.0 A ¹ | 100 W | PSE100A5 | PSE100B5 | PSE100C5 | PSE100D5 |
| 13.2 V | 7.60 A | 100 W | PSE100A13.2 | PSE100B13.2 | PSE100C13.2 | PSE100D13.2 |
| 15 V | 6.70 A | 100 W | PSE100A15 | PSE100B15 | PSE100C15 | PSE100D15 |
| 24 V | 4.20 A | 100 W | PSE100A24 | PSE100B24 | PSE100C24 | PSE100D24 |
| 48 V | 2.10 A | 100 W | PSE100A48 | PSE100B48 | PSE100C48 | PSE100D48 |

1) -25 to +55°C 100% load, 70°C at 75% load. With extra cooler, see picture at next page, the rating is 100% load at 70°C.

The table indicates the standard models.
 Other input and output combinations on demand.



PSE250-series 250 W DC/DC

FEATURES

18 to 300 V input
 12 to 48 V output
 Logic alarm
 Operating temp. -25 to +70°C,
 without derating
 Tropical coating
 Euroformat 10 & 12TE, 3HE
 DIN-rail, wall mounting or
 19" subrack

EMC & SAFETY

EN60950 class I
 EN61000-6-2, Immunity
 EN61000-6-3, Emission
 EN/IEC61000-4-4, 4 kV
 EN/IEC61000-4-5 level 2 & 3
 EN50121-3-2 & EN50121-4
 IEC62236-3-2 & IEC62236-4

OPTIONS

Series diode on output
 Train inputs
 Alarm relay with selectable NO/NC function

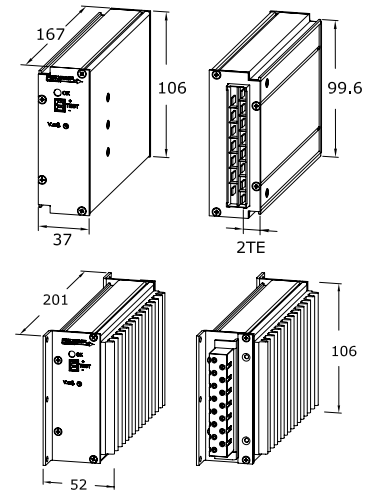

DIN or wall mounting
 Model with N (standard)

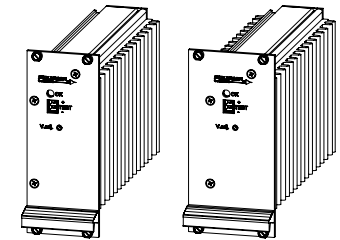

19" subrack mounting
 Model with L-panel (optional)

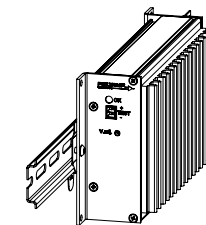

DIN-rail mounted
 Model with N (standard) + TS35 clips

| OUTPUT | | | INPUT | | | |
|---------|---------|-------|----------------|----------------|-----------------|-----------------|
| Voltage | Current | Power | 18 - 32 V | 41 - 60 V | 93 - 150 V | 185 - 300 V |
| 12 V | 12.5 A | 150 W | PSE150 24/12 | PSE150 48/12 | PSE150 110/12 | PSE150 220/12 |
| 13.2 V | 11.3 A | 150 W | PSE150 24/13.2 | PSE150 48/13.2 | PSE150 110/13.2 | PSE150 220/13.2 |
| 15 V | 10.0 A | 150 W | PSE150 24/15 | PSE150 48/15 | PSE150 110/15 | PSE150 220/15 |
| 24 V | 8.30 A | 200 W | PSE200 24/24 | PSE200 48/24 | PSE200 110/24 | PSE200 220/24 |
| 24 V | 10.4 A | 250 W | PSE250 24/24 | PSE250 48/24 | PSE250 110/24 | PSE250 220/24 |
| 48 V | 4.10 A | 200 W | PSE200 24/48 | PSE200 48/48 | PSE200 110/48 | PSE200 220/48 |
| 48 V | 5.20 A | 250 W | PSE250 24/48 | PSE250 48/48 | PSE250 110/48 | PSE250 220/48 |

Input range, is the range we guarantee full output performance, $U_{out} +10\%$, $I_{out} +5\%$ @+55°. The converter works down to the stop level -35%. The output voltage might decrease to approx -10% of nominal output at the stop level. The above table indicates the standard models. Other input and output combinations on demand.



PSC-series 150 W DC/DC

FEATURES

Wide input voltage range
 10 to 270 V input
 5 to 48 V output
 Up to three outputs
 Logic alarm
 Operating temp. -25 to +70°C,
 without derating
 Tropical coating
 Euroformat 10TE, 3HE
 DIN-rail, wall mounting or
 19" subrack

EMC & SAFETY

EN60950 class I
 EN61000-6-2, Immunity
 EN61000-6-3, Emission
 EN/IEC61000-4-4, 4 kV
 EN/IEC61000-4-5 level 2 & 3
 EN50121-3-2 & EN50121-4
 IEC62236-3-2 & IEC62236-4

OPTIONS

Series diode on output
 Train inputs
 Alarm relay with selectable NO/NC function
 Mechanical features, see page 19

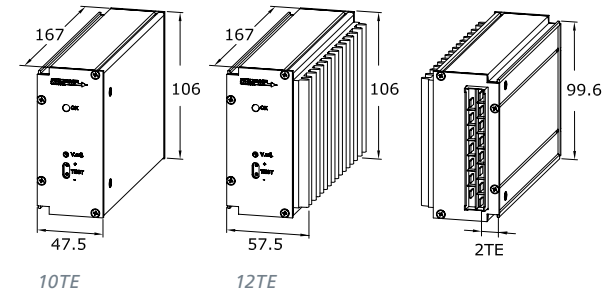

| SINGLE OUTPUT | | | DUAL OUTPUTS | | | | | TRIPLE OUTPUTS | | | | |
|---------------|---------------|-------------|---------------|---------------|-------------------|---------------|-------------|----------------|---------------|--------------|---------------|------------|
| Output | | Power | Master output | | Slave output | | Power | Master output | | Slave output | | Power |
| 5 V | 20.0 - 30.0 A | 100 - 150 W | 5 V | 10.0 - 20.0 A | 12 V | 1.20 - 2.0 A | 100 - 150 W | 5 V | 10.0 - 23.0 A | ±12 V | 1.20 - 2.00 A | 100 - 150W |
| 12 V | 8.00 - 12.5 A | 100 - 150 W | 5 V | 10.0 - 20.0 A | 15 V | 1.20 - 1.7 A | 100 - 150 W | 5 V | 10.0 - 20.0 A | ±15 V | 1.20 - 1.70 A | 100 - 150W |
| 24 V | 4.00 - 6.00 A | 100 - 150 W | 12 V | 7.30 - 11.0 A | 5 V ¹⁾ | 2.50 A | 100 - 150 W | | | | | |
| 48 V | 2.00 - 3.00 A | 100 - 150 W | 15 V | 5.00 - 8.00 A | 15 V | 1.20 - 2.00 A | 100 - 150 W | | | | | |
| | | | 24 V | 3.00 - 4.20 A | 24 V | 1.20 - 2.00 A | 100 - 150 W | | | | | |

¹⁾ Common zero with master output.

The above table indicates the standard models. Other input and output combinations on demand.

| DC WIDE INPUTS | | |
|----------------|-------------|----------------------|
| Input code | Input range | Nominal input |
| A | 10 - 30 V | 12, 24 V |
| B | 20 - 60 V | 24, 28, 36, 48 V |
| CT | 40 - 100 V | 48, 60, 72 V |
| C | 50 - 150 V | 72, 96, 110, 127 V |
| D | 90 - 270 V | 110, 127, 220, 250 V |

| POWER RANGES | | |
|--------------|-------|-----------|
| Modell | Watt | Dimension |
| PSC100 | 100 W | 10TE |
| PSC150 | 150 W | 10TE |
| | | |
| | | |



PSC240-series 240 W DC/DC

FEATURES

18 to 550 V input
 12 to 110 V output
 Logic alarm
 Operating temp. -25 to +70°C,
 without derating
 Tropical coating
 Euroformat 10TE, 12TE 3HE
 DIN-rail, wall mounting or
 19" subrack

EMC & SAFETY

EN60950 class I
 EN61000-6-2, Immunity
 EN61000-6-3, Emission
 EN/IEC61000-4-4, 4 kV
 EN/IEC61000-4-5 level 2 & 3
 EN50121-3-2 & EN50121-4
 IEC62236-3-2 & IEC62236-4

OPTIONS

Series diode on output
 Train inputs
 Alarm relay with selectable NO/NC function

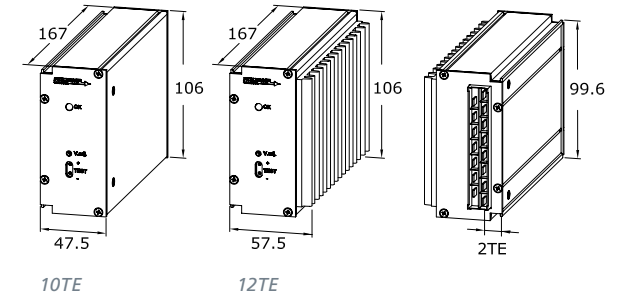

| OUTPUT | | | INPUT | | | | |
|---------|---------|-------|---------------|---------------|----------------|----------------|----------------|
| Voltage | Current | Power | 18 - 32 V | 38 - 60 V | 88 - 150 V | 175 - 300 V | 350 - 550 V |
| 12 V | 17.5 A | 210 W | PSC240 24/12 | PSC240 48/12 | PSC240 110/12 | PSC240 220/12 | ---- |
| 15 V | 14.0 A | 210 W | PSC240 24/15 | PSC240 48/15 | PSC240 110/15 | PSC240 220/15 | ---- |
| 24 V | 10.0 A | 240 W | PSC240 24/24 | PSC240 48/24 | PSC240 110/24 | PSC240 220/24 | PSC240 440/24 |
| 48 V | 5.00 A | 240 W | PSC240 24/48 | PSC240 48/48 | PSC240 110/48 | PSC240 220/48 | PSC240 440/48 |
| 110 V | 2.18 A | 240 W | PSC240 24/110 | PSC240 48/110 | PSC240 110/110 | PSC240 220/110 | PSC240 440/110 |

The above table indicates the standard models. Other input and output combinations on demand.

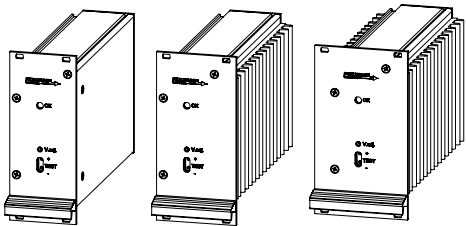

PSC-series for 19" subrack mounting
 Model with L-panel 10TE, 12TE and 14TE (optional)

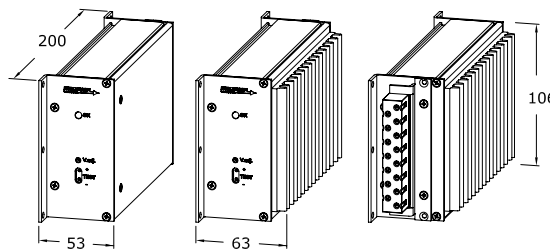

PSC-series for DIN or wall mounting
 Model with N (standard)

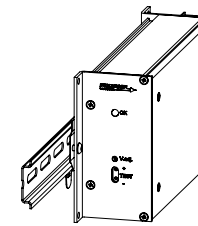

PSC-series DIN-rail mounted
 Model with N (standard) + TS35 clips

PM250-series 250 W DC/DC



FEATURES

11 to 60 V input
 13,2 to 48 V output
 Low ripple and noise
 Over voltage protection
 Output voltage alarm
 Series diode on output
 Operating temp. -25 to +55°C,
 without derating
 DIN-rail, wall mounting or
 19" rack

EMC & SAFETY

EN60950 class I
 EN61000-6-2, Immunity
 EN61000-6-3, Emission
 EN/IEC61000-4-4, 4 kV
 EN/IEC61000-4-5 level 2 & 3
 EN50121-3-2 & EN50121-4
 IEC62236-3-2 & IEC62236-4

OPTIONS

Train inputs
 Tropical coating
 Mechanical features, see page 20-21

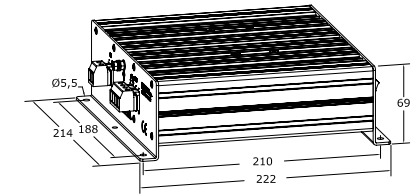

PM250/500 Standard for wall- or DIN mounting

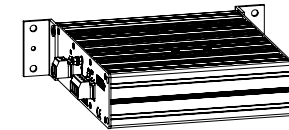

PM500 R wall mounted, brackets L58-1
 Option 400065

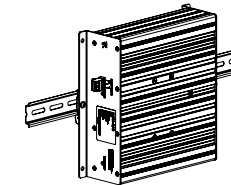

PM500 R DIN-rail mounted.
 Standard DIN-rail mounted TS35 clips

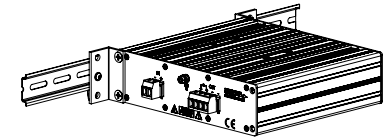

PM500 R DIN- or wall-mounted,
 brackets L58-1 + TS35 clips
 Option 400065

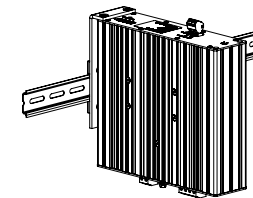

PM500 R DIN-rail mounted,
 bracket L58-2 + TS35 mounting plate
 Option 400064

| OUTPUT | | | INPUT | | |
|---------|---------|-------|---------------|---------------|---------------|
| Voltage | Current | Power | 11 - 16 V | 20 - 32 V | 41 - 60 V |
| 13.2 V | 14.1 A | 187 W | PM250 12/13.2 | | |
| 13.2 V | 18.9 A | 250 W | | PM250 24/13.2 | PM250 48/13.2 |
| 24 V | 7.80 A | 187 W | PM250 12/24 | | |
| 24 V | 10.4 A | 250 W | | PM250 24/24 | PM250 48/24 |
| 36 V | 5.20 A | 187 W | PM250 12/36 | | |
| 36 V | 6.90 A | 250 W | | PM250 24/36 | PM250 48/36 |
| 48 V | 3.90 A | 187 W | PM250 12/48 | | |
| 48 V | 5.20 A | 250 W | | PM250 24/48 | PM250 48/48 |

Input range, is the range we guarantee full output performance, Uout +10%, Iout +5% @+55°.
 The converter works down to the stop level -35%. The output voltage might decrease to approx -10% of nominal output at the stop level.
 The above table indicates the standard models. Other input and output combinations on demand.

PM500-series 500 W DC/DC



FEATURES

- 50 to 300 V input
- 13.2 to 110 V output
- Low ripple and noise
- Over voltage protection
- Output voltage alarm
- Series diode on output
- Operating temp. -25 to +55°C, without derating
- +70°C derating
- DIN-rail, wall mounting or 19" rack

EMC & SAFETY

- EN60950 class I
- EN61000-6-2, Immunity
- EN61000-6-3, Emission
- EN/IEC61000-4-4, 4 kV
- EN/IEC61000-4-5 level 2 & 3
- EN50121-3-2 & EN50121-4
- IEC62236-3-2 & IEC62236-4

OPTIONS

- Train inputs
- Tropical coating
- Mechanical features, see page 20-21

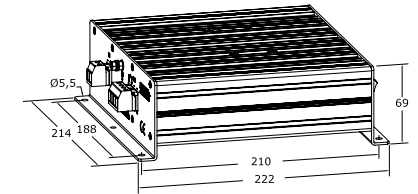

PM250/500 Standard for wall- or DIN mounting

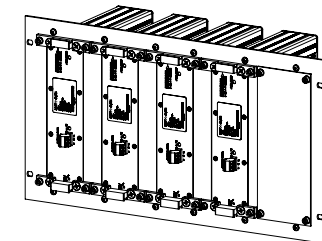
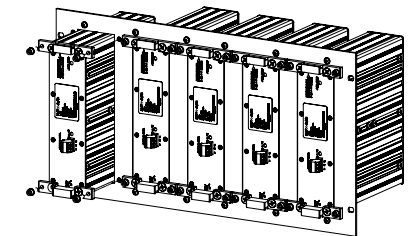
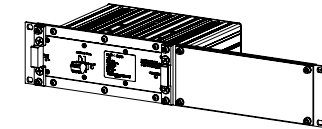
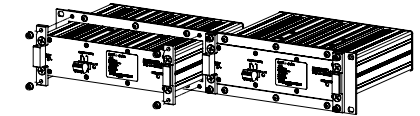

PM250/500 R 19" rack.

- 1) 19" front panel 2 U for two units (option 400062)
- 2) 19" front panel 2 U for two units with blind panel (option 400062)
- 3) 19" front panel 6 U for five units (option 400063)
- 4) 19" front panel 6 U for five units with blind panel (option 400063)

| OUTPUT | | | INPUT | | | |
|---------|---------|-------|-----------------|---------------|-----------------|---------------|
| Voltage | Current | Power | 50 - 150 V | 93 - 150 V | 100 - 300 V | 187 - 300 V |
| 13.2 V | 20.0 A | 260 W | PM260 110C/13.2 | | PM260 220D/13.2 | |
| 24 V | 20.0 A | 500 W | | PM500 110/24 | | PM500 220/24 |
| 48 V | 10.5 A | 500 W | | PM500 110/48 | | PM500 220/48 |
| 110 V | 4.50 A | 500 W | | PM500 110/110 | | PM500 220/110 |

Input range, is the range we guarantee full output performance, Uout +10%, Iout +5% @+55°.

The converter works down to the stop level -35%. The output voltage might decrease to approx -10% of nominal output at the stop level.

The above table indicates the standard models. Other input and output combinations on demand.

PU300-series 300 W DC/DC



FEATURES

- Wide input voltage range
10 to 270 V input
- 12 to 60 V output
- Over voltage protection
- Output voltage alarm
- Series diode on output
- Remote sense
- Inhibit / Power down input
- Operating temp. -25 to +55°C,
without derating
- Wall mounting or 19" rack

EMC & SAFETY

- EN60950 class I
- EN61000-6-2, Immunity
- EN61000-6-3, Emission
- EN/IEC61000-4-4, 4 kV
- EN/IEC61000-4-5 level 2 & 3
- EN50121-3-2 & EN50121-4
- IEC62236-3-2 & IEC62236-4

OPTIONS

- Train inputs
- Tropical coating
- Mechanical features, see page 22-23

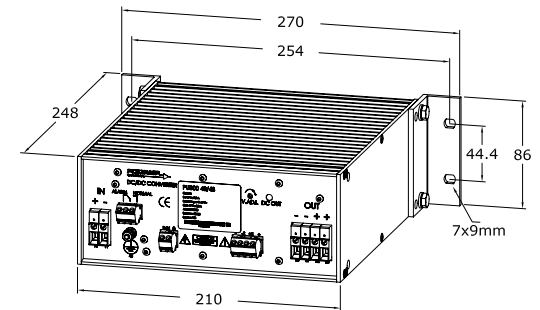

PU300/500 wallmounted. Brackets PL86-1 (standard)

| OUTPUT | | | INPUT | | | |
|---------|---------|-------|------------|------------|------------|------------|
| Voltage | Current | Power | 10 - 30 V | 20 - 60 V | 50 - 150 V | 90 - 270 V |
| 12 V | 18.0 A | 216 W | PU300A12 | | | |
| 12 V | 25.0 A | 300 W | | PU300B12 | PU300C12 | PU300D12 |
| 13.8 V | 16.0 A | 220 W | PU300A13.8 | | | |
| 13.8 V | 21.8 A | 300 W | | PU300B13.8 | PU300C13.8 | PU300D13.8 |
| 15 V | 16.0 A | 240 W | PU300A15 | | | |
| 15 V | 20.0 A | 300 W | | PU300B15 | PU300C15 | PU300D15 |
| 24 V | 10.0 A | 240 W | PU300A24 | | | |
| 24 V | 12.5 A | 300 W | | PU300B24 | PU300C24 | PU300D24 |
| 28 V | 8.58 A | 240 W | PU300A28 | | | |
| 28 V | 10.8 A | 300 W | | PU300B28 | PU300C28 | PU300D28 |
| 36 V | 6.67 A | 240 W | PU300A36 | | | |
| 36 V | 8.34 A | 300 W | | PU300B36 | PU300C36 | PU300D36 |
| 48 V | 5.00 A | 240 W | PU300A48 | | | |
| 48 V | 6.25 A | 300 W | | PU300B48 | PU300C48 | PU300D48 |
| 60 V | 4.00 A | 240 W | PU300A60 | | | |
| 60 V | 5.00 A | 300 W | | PU300B60 | PU300C60 | PU300D60 |

The above table indicates the standard models. Other input and output combinations on demand.

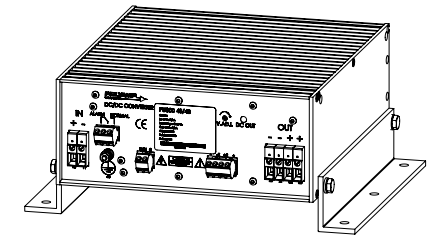

PU300/500 wallmounted, L216-1 (optional)

PU500-series 500 W DC/DC



FEATURES

- 18 to 300 V input
- 24 to 60 V output
- Over voltage protection
- Output voltage alarm
- Remote sense
- Inhibit / Power down input
- Operating temp. -25 to +55°C, without derating
- Wall mounting or 19" rack

EMC & SAFETY

- EN60950 class I
- EN61000-6-2, Immunity
- EN61000-6-3, Emission
- EN/IEC61000-4-4, 4 kV
- EN/IEC61000-4-5 level 2 & 3
- EN50121-3-2 & EN50121-4
- IEC62236-3-2 & IEC62236-4

OPTIONS

- Series diode on output
- Train inputs
- Tropical coating
- Mechanical features, see page 22-23

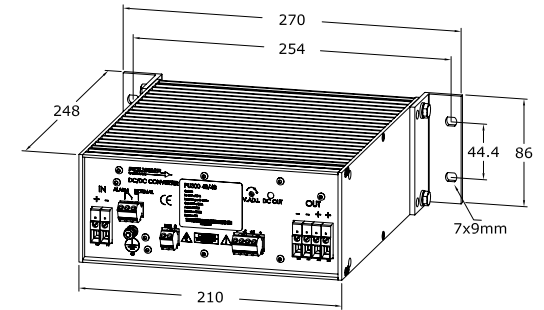

PU300/500 wallmounted. Brackets PL86-1 (standard)

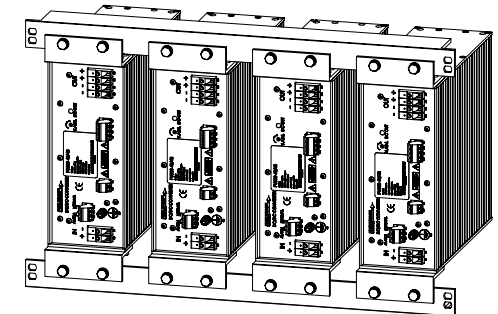
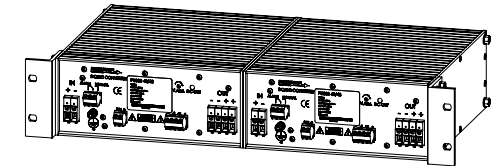
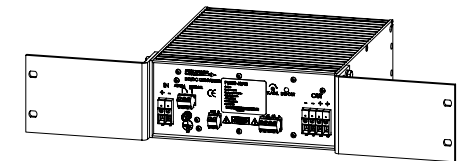

PU300/500 19" rack.

- 1) Brackets L86-3 (optional)
- 2) 19" rack mounting set (optional)
- 3) Standard brackets + L480-1 (optional)

| OUTPUT | | | INPUT | | | |
|---------|---------|-------|-------------|-------------|--------------|--------------|
| Voltage | Current | Power | 18 - 32 V | 38 - 60 V | 88 - 150 V | 175 - 300 V |
| 24 V | 16.7 A | 400 W | PU500 24/24 | | | |
| 24 V | 20.9 A | 500 W | | PU500 48/24 | PU500 110/24 | PU500 220/24 |
| 28 V | 14.3 A | 400 W | PU500 24/28 | | | |
| 28 V | 17.9 A | 500 W | | PU500 48/28 | PU500 110/28 | PU500 220/28 |
| 36 V | 11.2 A | 400 W | PU500 24/36 | | | |
| 36 V | 13.9 A | 500 W | | PU500 48/36 | PU500 110/36 | PU500 220/36 |
| 48 V | 8.34 A | 400 W | PU500 24/48 | | | |
| 48 V | 10.5 A | 500 W | | PU500 48/48 | PU500 110/48 | PU500 220/48 |
| 60 V | 6.67 A | 400 W | PU500 24/60 | | | |
| 60 V | 8.34 A | 500 W | | PU500 48/60 | PU500 110/60 | PU500 220/60 |

The above table indicates the standard models. Other input and output combinations on demand.



PSC600-series 800 W DC/DC

FEATURES

20 to 300 V input
 5 to 125 V output
 Operating temp. -25 to +70°C,
 without derating
 Tropical coating
 Euroformat 10TE to 14TE 6HE
 DIN-rail, wall mounting or
 19" subrack

EMC & SAFETY

EN60950 class I
 EN61000-6-2, Immunity
 EN61000-6-3, Emission
 EN/IEC61000-4-4, 4 kV
 EN/IEC61000-4-5 level 2 & 3
 EN50121-3-2 & EN50121-4
 IEC62236-3-2 & IEC62236-4

OPTIONS

Series diode on output
 Train inputs

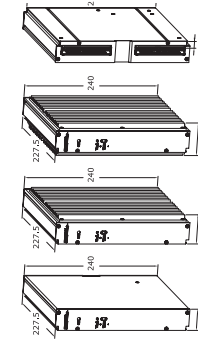

| OUTPUT | | | INPUT | | | |
|---------|---------|-------|---------------|---------------|----------------|----------------|
| Voltage | Current | Power | 20 - 32 V | 41 - 60 V | 93 - 150 V | 187 - 300 V |
| 5 V | 60.0 A | 300 W | PSC300 24/5 | PSC300 48/5 | PSC300 110/5 | PSC300 220/5 |
| 12 V | 33.0 A | 400 W | PSC400 24/12 | PSC400 48/12 | PSC400 110/12 | PSC400 220/12 |
| 12 V | 60.0 A | 720 W | ---- | PSC700 48/12 | PSC700 110/12 | PSC700 220/12 |
| 15 V | 27.0 A | 400 W | PSC400 24/15 | PSC400 48/15 | PSC400 110/15 | PSC400 220/15 |
| 15 V | 54.0 A | 800 W | ---- | PSC800 48/15 | PSC800 110/15 | PSC800 220/15 |
| 24 V | 25.0 A | 600 W | PSC600 24/24 | PSC600 48/24 | PSC600 110/24 | PSC600 220/24 |
| 24 V | 33.0 A | 800 W | ---- | PSC800 48/24 | PSC800 110/24 | PSC800 220/24 |
| 48 V | 12.5 A | 600 W | PSC600 24/48 | PSC600 48/48 | PSC600 110/48 | PSC600 220/48 |
| 48 V | 17.0 A | 800 W | ---- | PSC800 48/48 | PSC800 110/48 | PSC800 220/48 |
| 110 V | 5.50 A | 600 W | PSC600 24/110 | PSC600 48/110 | PSC600 110/110 | PSC600 220/110 |
| 110 V | 7.30 A | 800 W | ---- | PSC800 48/110 | PSC800 110/110 | PSC800 220/110 |
| 125 V | 4.80 A | 600 W | PSC600 24/125 | PSC600 48/125 | PSC600 110/125 | PSC600 220/125 |
| 125 V | 6.40 A | 800 W | ---- | PSC800 48/125 | PSC800 110/125 | PSC800 220/125 |

Input range, is the range we guarantee full output performance, Uout +10%, Iout +5% @+55°.
 The converter works down to the stop level -35%. The output voltage might decrease to approx -10% of nominal output at the stop level.
 The above table indicates the standard models. Other input and output combinations on demand.

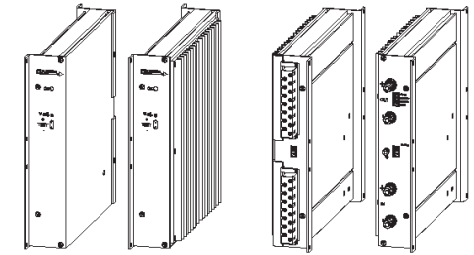

PSC600-series for DIN- or wall-mounting, Model with N (std)
 Model with H15-screw and M6 bolts/studs

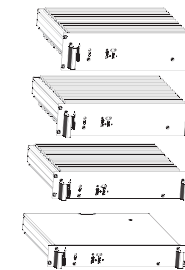

PSC600-series for 19" subrack mounting,
 Model with L-panel 10TE, 12TE and 14TE (optional)

PU1000-series 1000 W DC/DC



FEATURES

- 18 to 300 V input
- 24 to 110 V output
- Over voltage protection
- Output voltage alarm
- Series diode on output
- Remote sense
- Inhibit / Power down input
- Current sharing in parallel mode
- Operating temp. -25 to +55°C, without derating
- Wall mounting or 19" rack

EMC & SAFETY

- EN60950 class I
- EN61000-6-2, Immunity
- EN61000-6-3, Emission
- EN/IEC61000-4-4, 4 kV
- EN/IEC61000-4-5 level 2 & 3
- EN50121-3-2 & EN50121-4
- IEC62236-3-2 & IEC62236-4

OPTIONS

- Train inputs
- Tropical coating
- Mechanical features

PU1000 has a wide input voltage version with 600 W output power, the PU600-series. Consult www.polyamp.com

| OUTPUT | | | INPUT | | | | |
|---------|---------|--------|---------------|---------------|---------------|----------------|----------------|
| Voltage | Current | Power | 18 - 32 V | 38 - 60 V | 50 - 90 V | 88 - 150 V | 175 - 300 V |
| 24 V | 33.4 A | 800 W | PU1000 24/24 | | | | |
| 24 V | 41.7 A | 1000 W | | PU1000 48/24 | PU1000 72/24 | PU1000 110/24 | PU1000 220/24 |
| 28 V | 28.6 A | 800 W | PU1000 24/28 | | | | |
| 28 V | 35.7 A | 1000 W | | PU1000 48/28 | | PU1000 110/28 | PU1000 220/28 |
| 48 V | 16.7 A | 800 W | PU1000 24/48 | | | | |
| 48 V | 20.9 A | 1000 W | | PU1000 48/48 | PU1000 72/48 | PU1000 110/48 | PU1000 220/48 |
| 60 V | 13.4 A | 800 W | PU1000 24/60 | | | | |
| 60 V | 16.7 A | 1000 W | | PU1000 48/60 | PU1000 72/60 | PU1000 110/60 | PU1000 220/60 |
| 85 V | 11.8 A | 1000 W | | PU1000 48/85 | PU1000 72/85 | PU1000 110/85 | PU1000 220/85 |
| 110 V | 7.28 A | 800 W | PU1000 24/110 | | | | |
| 110 V | 9.09 A | 1000 W | | PU1000 48/110 | PU1000 72/110 | PU1000 110/110 | PU1000 220/110 |

The above table indicates the standard models. Other input and output combinations on demand.

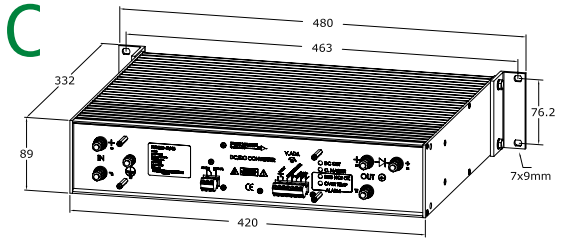

PU600/1000 Wallmounted. Brackets L89-1 (standard)

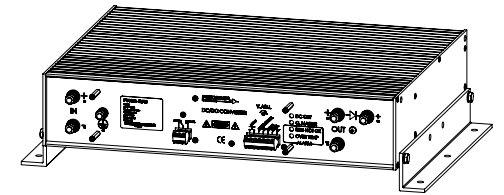

PU600/1000 Wallmounted. Brackets L300-1 (optional)

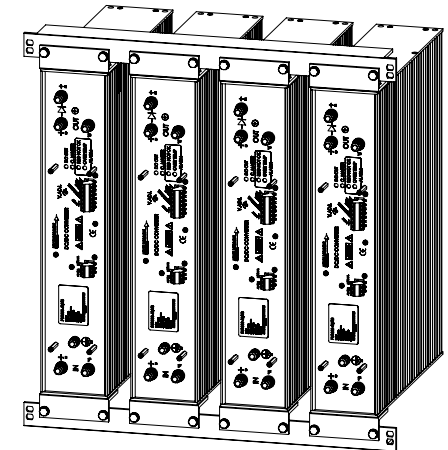
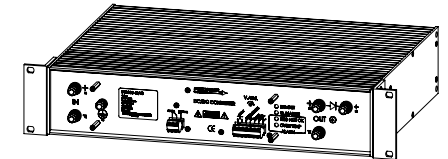

PU600/1000 19" rack.

- 1) Standard brackets L89-1, 19" rack
- 2) Standard brackets + L480-2 (optional)

PC1000-series 1000 W DC/DC



FEATURES

- 17 to 300 V input
- 24 to 48 V output
- Over voltage protection
- Output voltage alarm
- Remote sense
- Current sharing
- Inhibit / Power down input
- Inrush current limit
- Convection cooled
- Operating temp. -25 to +55°C, without derating
- Wall mounting or 19" rack

EMC & SAFETY

- EN60950 class I
- EN61000-6-2, Immunity
- EN61000-6-3, Emission
- EN/IEC61000-4-4, 4 kV
- EN/IEC61000-4-5 level 2 & 3
- EN50121-3-2 & EN50121-4
- IEC62236-3-2 & IEC62236-4

OPTIONS

- Series diode on output
- Train inputs
- Tropical coating
- Mechanical features, see page 26-27

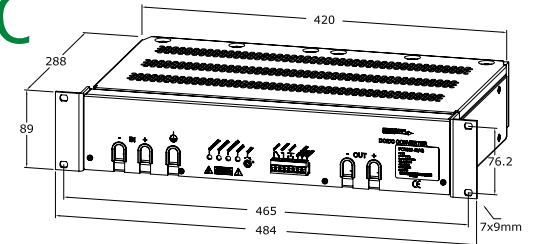

PC1000/2000 Rackmounted 19" 2U. Brackets L89-3 (std)

| OUTPUT | | | INPUT | | | |
|---------|---------|--------|--------------|--------------|---------------|---------------|
| Voltage | Current | Power | 20 - 32 V | 43 - 60 V | 93 - 150 V | 187 - 300 V |
| 24 V | 42.0 A | 1000 W | PC1000 24/24 | PC1000 48/24 | PC1000 110/24 | PC1000 220/24 |
| 28 V | 36.0 A | 1000 W | PC1000 24/28 | PC1000 48/28 | PC1000 110/28 | PC1000 220/28 |
| 36 V | 28.0 A* | 1000 W | PC1000 24/36 | PC1000 48/36 | PC1000 110/36 | PC1000 220/36 |
| 48 V | 21.0 A | 1000 W | PC1000 24/48 | PC1000 48/48 | PC1000 110/48 | PC1000 220/48 |

* NRE might be charged.

Input range, is the range we guarantee full output performance, Uout +10%, Iout +5% @+55°.

The converter works down to the stop level -35%. The output voltage might decrease to approx -10% of nominal output at the stop level.

The above table indicates the standard models. Other input and output combinations on demand.

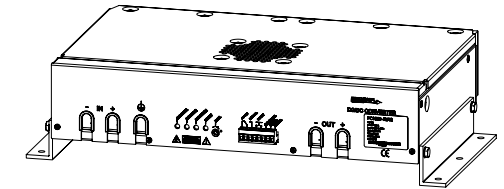

PC1000/2000 Wallmounted. Brackets L216-1 (optional)

PC2000-series 2000 W DC/DC



FEATURES

- 33 to 300 V input
- 24 to 48 V output
- Over voltage protection
- Output voltage alarm
- Remote sense
- Current sharing
- Inhibit / Power down input
- Inrush current limit
- Convection cooled 1000 W
- Operating temp. -25 to +55°C, without derating
- Wall mounting or 19" rack

EMC & SAFETY

- EN60950 class I
- EN61000-6-2, Immunity
- EN61000-6-3, Emission
- EN/IEC61000-4-4, 4 kV
- EN/IEC61000-4-5 level 2 & 3
- EN50121-3-2 & EN50121-4
- IEC62236-3-2 & IEC62236-4

OPTIONS

- Series diode on output
- Train inputs
- Tropical coating
- Mechanical features, see page 26-27

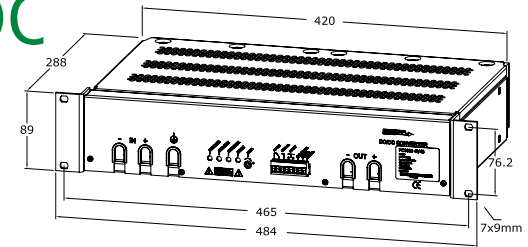

PC1000/2000 Rackmounted 19" 2U. Brackets L89-3 (std)

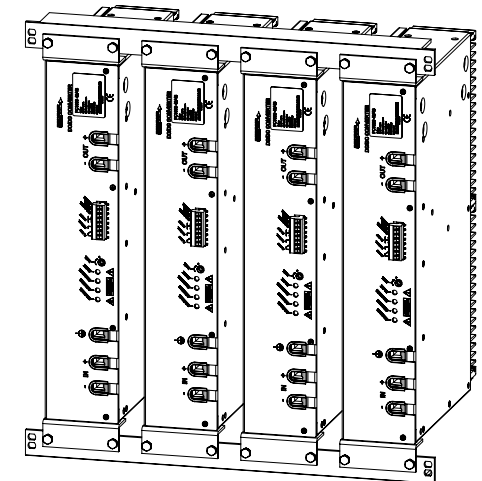
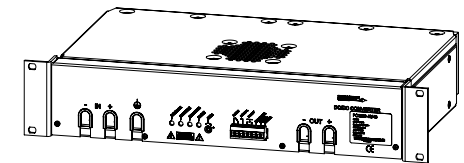

PC1000/2000 19" rack.

- 1) Standard brackets
- 2) Standard brackets + L480-2 (optional)

| OUTPUT | | | INPUT | | | |
|---------|---------|--------|--------------|---------------|---------------|---------|
| Voltage | Current | Power | 43 - 60 V | 93 - 150 V | 187 - 300 V | Cooling |
| 24 V | 58.0 A | 1400 W | PC1400 48/24 | PC1400 110/24 | PC1400 220/24 | FAN |
| 28 V | 50.0 A | 1400 W | PC1400 48/28 | PC1400 110/28 | PC1400 220/28 | FAN |
| 36 V | 39.0 A* | 1400 W | PC1400 48/36 | PC1400 110/36 | PC1400 220/36 | FAN |
| 48 V | 42.0 A | 2000 W | PC2000 48/48 | PC2000 110/48 | PC2000 220/48 | FAN |

* NRE might be charged.

Input range, is the range we guarantee full output performance, $U_{out} +10\%$, $I_{out} +5\%$ @+55°.

The converter works down to the stop level -35%. The output voltage might decrease to approx -10% of nominal output at the stop level.

The above table indicates the standard models. Other input and output combinations on demand.

Special models

Military vehicle applications

DC/DC converters for Military vehicle applications with MIL-STD 1275D 28 V input and output 12, 24, 48 V for equipment supply and 100 to 150 V for motor drive of moving equipment's. Continuous output power 500 W with peak current capacity for motor drive applications. MIL-STD 461E high immunity RS103 100 to 200 V/m and low emissions. Case and connection rated IP54.



Military vehicle DC/DC converters

The DC/DC converter PU300 12/27 and PU500 24/28 supply an insulated stable low noise 28 V for radios used in modified vehicles used by UN troops and fast attack boats.



DC/DC converter PU300 12/27

DC UPS PA356, 12 V fast charging

In large storages the handling forklifts are used during several shifts. Instead of charging the whole forklift vehicle they use interchangeable battery modules. To change such battery it takes some minutes. On the forklift, the driver has direct contact with the logistic system via a computer connected to a WiFi network. Those computers use Windows® Operating system and they do not like sudden power down. Polyamp developed together with suppliers of forklift computers a DC UPS that overcome this problem.

The DC-UPS works for about 15 minutes. It use the RS232 standard UPS signaling methods supported by Windows® to switch off the computer in a controlled manner.

The battery is an environmental friendly NiMh. The integral battery charger can fully charge the battery within 2 hours, as many such situations can happen per day. In normal operation it supplies the computer and charge the battery.

Input voltage +18 V 2.7 A
 Rated power in UPS mode: 30 W 12 V 3 A. (Uout =10.5 V)
 Stop voltage: 10 V.

PM50B18-18 and PM50C18-18 are optimized to supply the DC-UPS, please see page 12.



DC/DC converter 48/270 Vdc, PSC600 48/135, 2 units in series mode

PA355 4 x 12 mA constant current source

PA355 is a constant current source with 4 outputs. It is used to supply current to safety relays on train or track-side applications. It automatically compensate for changes in feeding cable lengths up to 4 km. PA355 is able to feed 4 individual relays, with common zero. Each output has surge arrestors as protection.

It also handles a redundant input voltage (110 V) with individual alarms. The voltage source is usually one or two (for redundancy) PM50C60-60, please see page 12.

| | |
|--------------------|--------------------------------|
| Iout1= 10 or 12 mA | Uout max = 120 V |
| Iout2= 10 or 12 mA | Uout min = 40 V |
| Iout3= 10 or 12 mA | Uin alarm: Max 30 Vd.c.; 0,1 A |
| Iout4= 10 or 12 mA | Ta = -20 to +55°C |

EMC According to SS4361503 PL5

Railway Smoke & Fire standard EN 45545

The purpose of EN 45545 is that train coaches are designed in such a way that passengers have enough time to evacuate in case of emergency. With a small modification, most of our DC/DC converters falls in the category of "non listed product" of EN45545-5 and by using the installation criteria of EN 45545-2 with < 100 g fire load, they can be installed in a non-fire enclosure environment.



Fire and Smoke

DC Power System Configurations

Systems Configurations

Polyamp supplies customized power systems with DC/DC converters in 19"-subrack with 3U/3HE or 6U/6HE units. They are based on our Euro cassettes with PSE100 up to PSE250 series with 3HE or PSC600 series with 6HE units.

We use solutions with back planes or complete cabled with connectors. Hot plug-in with DC/DC converters is possible. However as they have to be individually fused at the distribution point, this function is really not relevant for DC/DC converters. At high input voltages e.g. 110 Vd.c. its not recommended, even with clever inrush current circuits (that PSC600 uses).

We have specially designed cabinets for railway applications or standard subracks for Telecom, Power plants, Process industry and other applications.

Mixed outputs

The photo below shows a system where the outputs are mixed to form a unit that supplies +5 V 20-30 A, ±12V 3 A and +24 V 1.5 A. In this case the Euroformat cassettes are not visible.



Multi output system

Safety Critical Systems

The photo below is an example of Safety Critical power supply system where 2 different input batteries are used (A and B) with 2 or 3 redundant units per group. All outputs are parallel connected with alarm signalization.



Safety Critical system, with 2 x N+1 configuration

Power supplies or DC/DC blowing fuses

There are two scenarios to blow a fuse; the load has a slow decrease of performance or the load has a sudden short circuit. The later can be a problem for a power supply to generate a peak current enough to blow a fuse. However if the power supply or DC-DC converter supply a single load their own current limit will protect the load, then a "battery fuse" is not needed.

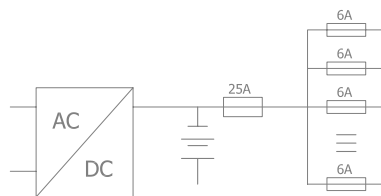

This figure shows a traditional battery charging system with a battery and battery fuse. After that is the downstream fuse distribution.

By definition, in a fuse distribution the secondary loads has smaller fuses than the main rated current. If the "downstream" fuses are 1/3 - 1/4 of the total load, the power supply will blow the fuse as well as a battery does. Therefore it is a question of dimensioning the distribution system correctly.

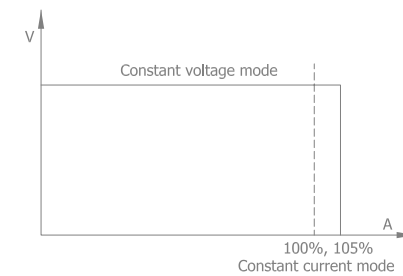

Rectangular current limit characteristic of Polyamp DC/DC converters

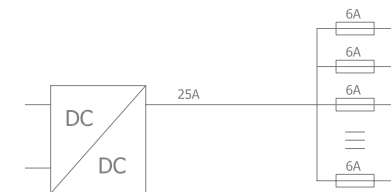

A distribution system using power supplies or DC-DC converters without "battery fuse".

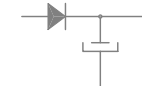

If the distance is large to the fuse distribution point, a large electrolytic capacitor together with a series diode might be needed. That is also valid for battery supplied systems.

Magnetic and Electric Signature Control

Degaussing systems

Modern influence sea mines detect the magnetic disturbance of a vessel in the Earth's Magnetic Field, this is referred to as the vessel's magnetic signature. This signature is the most significant influence of those used to trigger the mine. To minimize this threat naval vessels are fitted with an on-board Degaussing System (DG). The DG reduces the signature with a counter-acting field, generated from a coil system, connected to loop-coil current amplifiers. Typical 90-95% of the ship's signature can be neutralized with a well designed 3-dimensional DG system. Polyamp specializes in Advanced Degaussing Systems (ADG), which in general terms means that each coil is individually controlled by one loop coil amplifier (BPAU) and that the coil system is 3-dimensional.

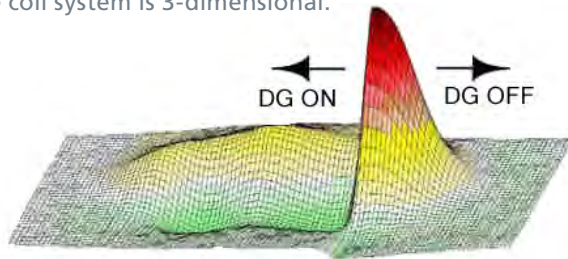

Magnetic signature management

Naval operational priorities have shifted from blue water to brown/shallow water. This means that the threat is increased as ships come much closer to the influence mines. Better degaussing systems than previously used are therefore now required. The answer to this increased threat is ADG. Polyamp have delivered over 45 DG systems, all of which are computer controlled Advanced Degaussing Systems.

Polyamp offer several types of loop-coil amplifiers for installation on different sizes of vessels. The location of the loop coil amplifiers can either be centralized in racks or modern distributed amplifiers close to the degaussing coil. The ADG methodology improves the signature performance and the time and effort needed in ranging relative to a system with only a few large amplifiers.



Typical degaussing control unit DCU

A Polyamp ADG is normally controlled by one or more magnetometers to achieve a low signature. Several fallback control modes are available, including Gyro Geomagnetic map and manual, depending on the system layout.

With ADG the signature is adjusted by changing loop-coil currents. Worldwide operation can be maintained without the need to change connections at the junction boxes or to check ranging before entering the operational area. The ADG ranging process is much faster, especially when using SWECADE ranging data acquisition and measurement software with coil modeling.

Remote control from the range office can be achieved, quickly and safely by simply connecting a transceiver to the DG system.

The Polyamp powerful ADG systems enable significant savings on the overall installation cost and weight to be achieved by using less and thinner degaussing coil cables. This is of significant benefit to the shipyard.

The ADG is also ideally suitable for the modern principles of sectional building of ships. The location of the degaussing system components is very flexible and there is no need of a special dedicated operators console to run the ADG. The console function can be one of many other software applications in any suitable PC workstation onboard the vessel.

Polyamp ADG advantages:

- Systems suitable from the smallest vessels up to large air craft carriers
- Turnkey capability including system design, equipment supply and proving trials
- Favourable total ownership cost
- Efficient signature handling with prediction, control and evaluation
- Modular and digital open systems, upgradeable for future threats
- Cost effective procurement



Loop coil amplifier (BPAU)

Magnetic and Electric Signature Control

UEP and ELFE Measurement Systems

Underwater Electric Potentials (UEP) are produced by cathodic currents in the ship or submarine hull and also from propeller or other metallic materials in contact with salt water. A ship's electric potential signature is therefore generated in a similar way as the magnetic signature. This can also be used as an input or trigger signal in an influence mine. The ship's movement also produces an Extra Low Frequency Electric field (ELFE) that can be used for positioning, target evaluating or for reconnaissance.

Polyamp have developed a range of sensors and platforms for the measurement of these electric signatures for use in:

- Upgrading conventional sea ranges
- Transportable sea ranges
- Reconnaissance, fixed or mobile equipments
- Influence sea mines

All the Polyamp sensors and platforms use a unique and patented Polyamp carbon fibre electrode sensor which is very sensitive. The mechanical robustness, handling and life expectancy of sensors using carbon fibre technology make it much more versatile for these applications compared to other electrode types.

Polyamp can supply a complete system package with electrodes, very low noise amplifiers, data acquisition, analysis, presentation and documentation with the SWECADE® Range Software Package.

Polyamp UEP and ELFE Systems - Key features

- Carbon Fibre Electrodes - Robust Technology
- Very Low Noise Amplifiers - High Sensitivity
- Salinity Independent - Useable for All Waters Instantaneously
- Inert Sensors - Maintenance Free Without Need for Salt Bridges
- Rapid Deployment - No Operational Delays
- High Reliability - Long Life Expectancy
- 3 Axis Platform Designs - Fixed and Transportable Ranges



Multi Influence Sensor System UMISS

Multi Influence Sensor Systems

UMISS® is a family of Multi Influence Sensors Systems designed to measure Underwater Signatures. UMISS® is designed for use as a single unit or with several UMISS® sensors, combined in a full range application.

The UMISS® Sea Module is equipped with magnetic, electric and pressure sensors and an optionally acoustic sensor. Underwater signatures are measured for fixed & mobile ranging and surveillance applications such as for harbour protection.

Digitalization of sensor data takes place in 24 bits ADC's and synchronizations and packaging of data in a FPGA plus a Microcontroller. To send the UMISS® digitalized sensor data to shore a special Ethernet cable (copper or optical) is used alternatively encrypted WLAN radio communications. The signature analysis is then made in a PC using a special version of the Polyamp SWECADE® software.

UMISS® is designed for easy deployment from a small workboat with minimized requirement for diver assistance. The Sea Module is also equipped with highly accurate 2-axis inclination sensor unit. Data from this unit and the static 3-axis magnetic sensor enable compensation for non horizontal positions of the Sea Module to be made during subsequent analysis.

Magnetic and Electric Signature Control

Signature Management

Underwater signatures from ships, used for mine-fusing and detection should be known and controlled for each naval vessel before entering a mission.

SWECADE® is a software package for magnetic, electric and pressure signature management. It has been developed in co-operation with FMV (the Swedish Defence Material Administration) to be the main tool in prediction, design and evaluation of non-acoustic underwater ship-signatures.

SWECADE® has been used at all Swedish ranges (Sea and land) since 1995 and, in its present version, it is also adapted for transportable/moveable ranges.

SWECADE® runs on any standard PC using Windows operating system and can read sensor values from a file or use ADC-boards for data acquisition.

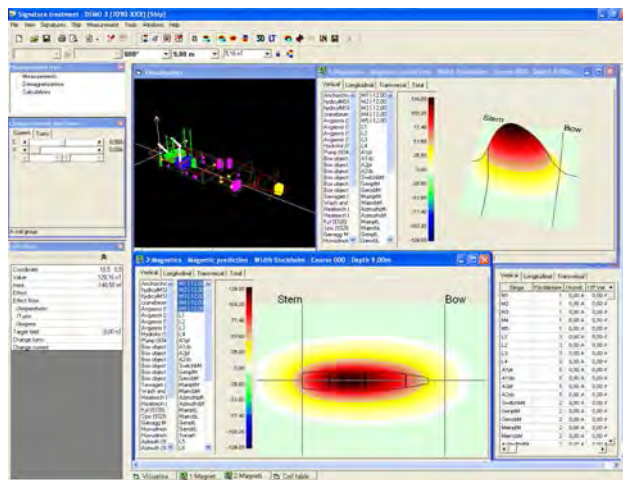

SWECADE® screenshot

The three modules in SWECADE® are:

The component signature prediction module offers:

- The calculated magnetic signature at any depth and ambient field
- Modular build up of whole ship set of components (engines, gears etc.)

The loop-coil design package features:

- Design of loop-coils for components, a ship or a ship class
- 3D graphic displays of cable routes
- Prediction of coil-effects at any distance

The range utilities are optimized for:

- Signal processing and data management
- Quick, semi-automatic, coil prediction and definition of optimum settings
- Powerful display and print routines
- Built in training for operators and degaussing technicians

"SWECADE® Software, the optimal tool for electromagnetic signature management!"

Signatures in the reality

During the years SWECADE® has been used for signatures predictions and ranging on both larger and smaller steel hulled vessels, submarines and MCMV's projects with very successful results.

With features to the able to use a synthesis of both real measurements results in combination with predictions results the SWECADE® softer to has proved to be a very useful, precise and accurate tool in the electric magnetic signature management area.

A FFT software module to SWECADE® can also perform frequency analysis of both electric and magnetic signatures as well as pressure and acoustic signatures. Different FFT windows, filtering functions and more are made available in this software module.



SWECADE® FFT Software module

Magnetic and Electric Signature Control

Magnetic and Electric Sweep Supply

Influence sea mines detect different parameters and the prime triggering parameter is normally the magnetic signature. Modern mines may also use Underwater Electric Potential (UEP) fields as a trigger. Influence minesweeping replicates ships-like signatures of the magnetic and electric influences that will trigger the modern sea mine. Specialized low signature MCM vessels, or remote controlled vessels, performing minesweeping are equipped with a mine sweep power supply system and a towed mine sweep load simulating the target signature.

The Polyamp MSS2000 Mine sweep supply system has a modular design with several power modules which supply multiple sweep loads forming the active target signature. Sweep loads can be modular magnetic coils, acoustic generators, UEP sweep etc. The MSS2000 can also add an AC stray field to form a full ship-like signature with both DC and AC field. Together with the Polyamp Sweep Profiler software package, ship-like signatures can be simulated by the mine sweep. Generated sweep signatures are software controlled and a new target signature can be selected at any moment. Swept route effect data can be transferred to the ships command and control system enabling swept route evaluation in real time.

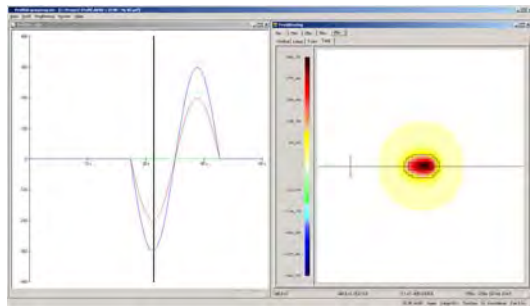

MSS 2000® ships profiler

Representative Signature Control Projects performed by POLYAMP

Ships projects

RSwN, Sweden



Stockholm Class



Göteborg Class



Visby Class



Gotland Class

RD, Denmark



Absalon Class



Knut Rasmussen Class



Ivar Huitfeldt Class



MSD Class

Sensor projects



DGA GESMA, France
DCNS, France



GOA ELFE Range, India



Landsort Class



Styrsö Class

USN, USA



LPD 17 San Antonio Class



CVN 77 Carrier

RSN, Singapore



Bedok Class



Challenger Class



RSwN ELFE Range, Sweden



Various Internal projects

About Polyamp

The Systems Division of Polyamp specializes in the design, manufacture and supply of Underwater Electromagnetic Signature Management and Control Systems for Worldwide application within the International Naval Industry / International Navy authorities.

The type of systems supplied are Advanced Degaussing systems for surface and submarine naval vessels. Electromagnetic Mine Sweep supply, Underwater Electric Potential (UEP/ELFE) sensors and electromagnetic design and measurement systems.

The SWECADE software can predict and design coil systems, dimension Degaussing systems, control fixed and movable ranges, support signature analyze and document the fleet vessels signature history.

Polyamp Power division specializes in design and production of mainly DC/DC converters and some compatible Power supplies. Our DC/DC converters are used in applications demanding high reliability in rough environments. Thru the years countless applications in sectors like Railway, Energy, Process control, Vehicles, Military, Radio and Telecom etc.

We provide our DC/DC converters to customers worldwide, with an established sales distributor network or directly where we do not have a distributor. Polyamp have three locations; the head office in Sollentuna suburb to Stockholm, Sweden. We have design and manufacturing of DC/DC converters in Åtvidaberg 230 km south of Stockholm and La Chaux-de-Fonds in Switzerland.

Our DC/DC converters have practical MTBF > 1 Million hours and our official warranty is two years. However in case we discover a fault due to workmanship the warranty is much longer than that. We have no dedicated service department as we have worked with quality assurance methods since end of 1980-ties. Our delivery accuracy is around 98% on time, in a day to day basis and delivers to just-in-time schemes. Our quality system is approved for Nuclear Plants Class 1E.



HEAD OFFICE

Polyamp AB
Box 925
SE-191 29 Sollentuna
Sweden
Phone: +46 8 594 693 00
Telefax: +46 8 594 693 05

SALES OFFICES

Polyamp AB
Box 229
SE-597 25 Åtvidaberg
Sweden
Phone: +46 120 854 10
Telefax: +46 120 854 05

Email: info@polyamp.se
www.polyamp.com

Switch Craft S.A
Ruel bel Air 63
CH-2300 La Chaux-de-fonds
Switzerland
Phone: +41 32 96 78800
Telefax: +41 32 96 78809

Distributor

