



RONDEX-JUWEL®
Supplement to catalogue

Index

>> 01

**Control unit series
RONDEX-JUWEL®**

page 02

→ About Us

Control Units

Panel Mount Jacks

Bus Technology

Enclosures

Terminal Blocks

Pedal Switches

Limit Switches

Type Index



Front dimensions: \varnothing 28 mm
Panel cut-out: \varnothing 22.3 mm
Front bezel height: 2 mm
Travel: 6 mm



RONDEX-JUWEL®

 Product configurator



Overview RONDEX-JUWEL® series



- | | | |
|----|------------------------|---------|
| 01 | Pushbutton Heads | page 08 |
| 02 | Emergency-stop Buttons | page 10 |
| 03 | Selector Heads | page 11 |
| 04 | Key Actuators | page 13 |
| 05 | Panel Mount Jacks | page 17 |
| 06 | Pilot Light Heads | page 18 |

Contact Blocks/Lampholders

see page 408
in the product
catalogue



IP65 degree of protection

↓ 6mm operating travel

 illuminating option

 labelling option

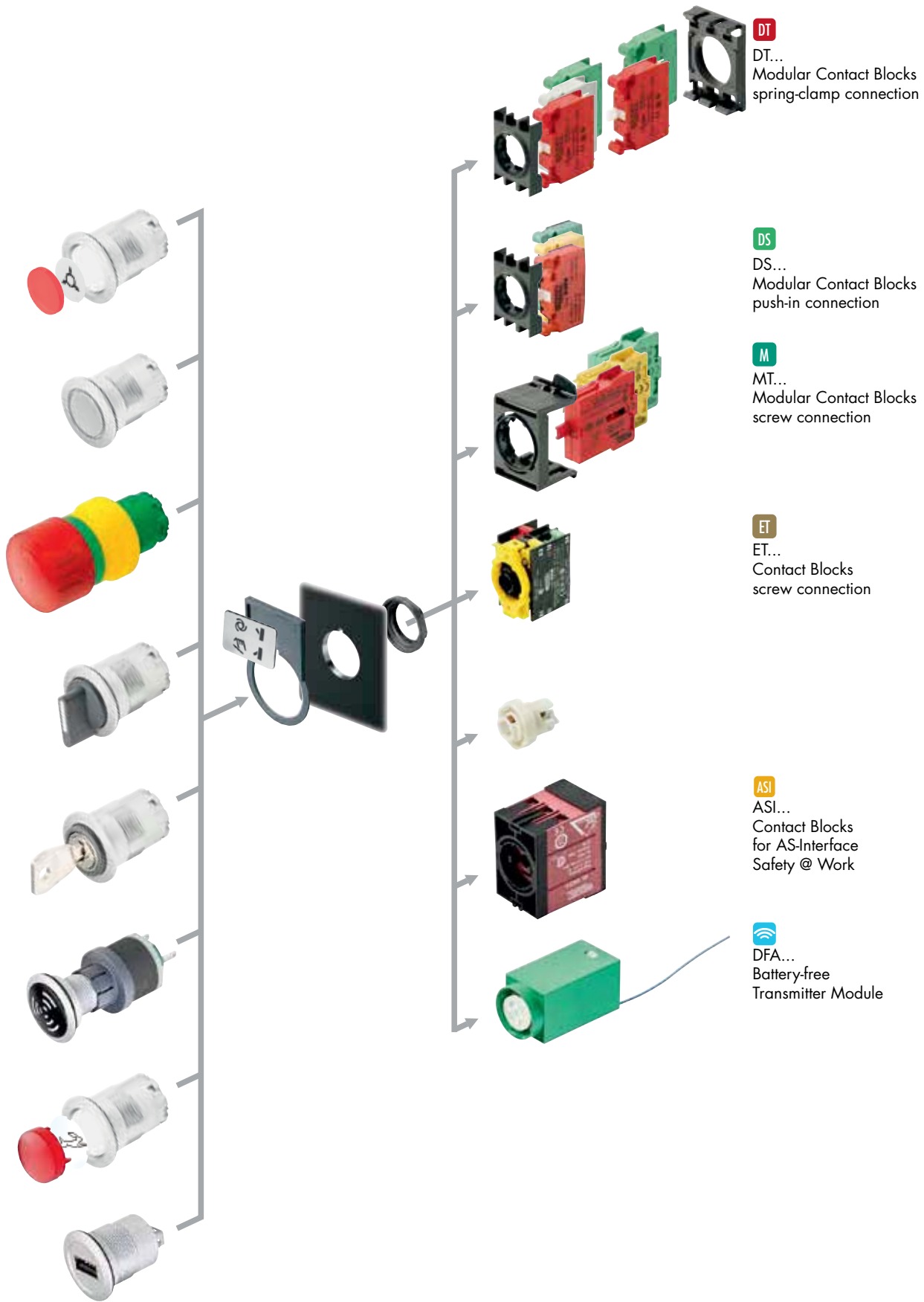

Ø 22.3 mm

Mounting Depth Dimensions

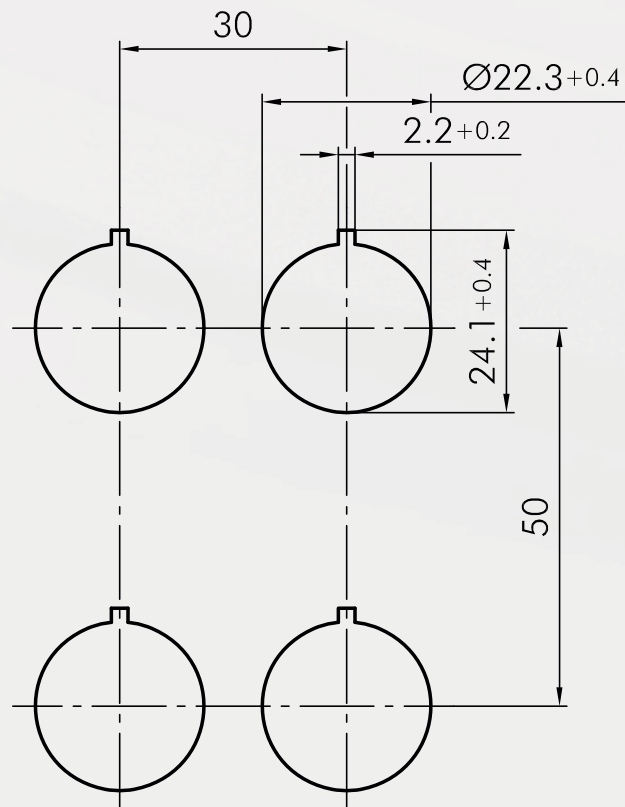
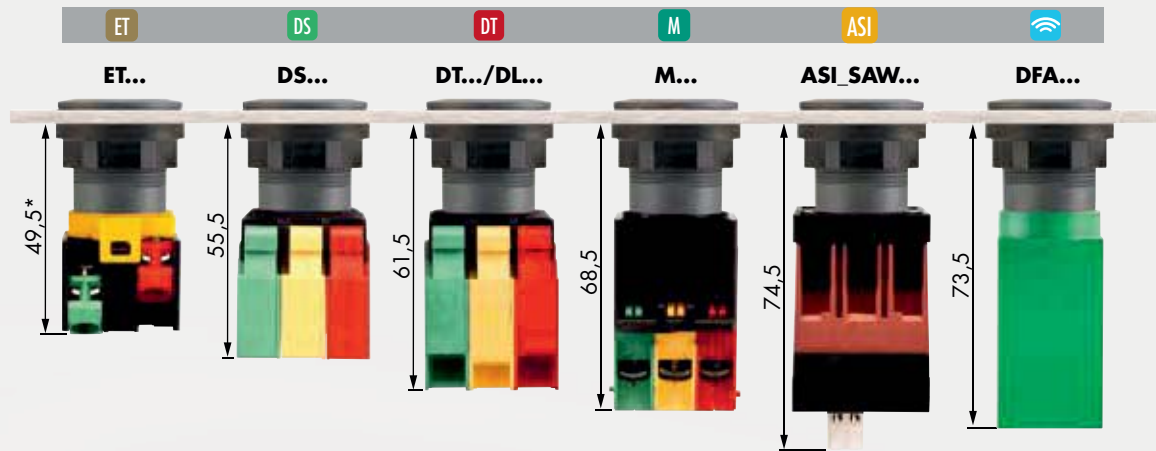

Mounting and Service Instructions

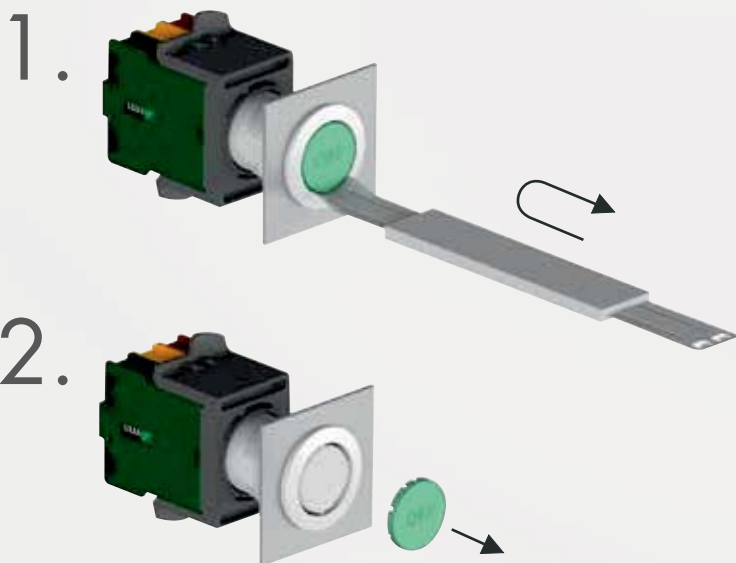

Ø 22.3 mm

Pushbutton Heads

Lenses and nameplates to be ordered separately

Illustration

Dimensions

Description



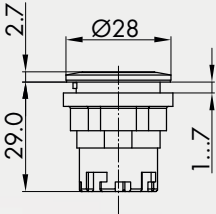

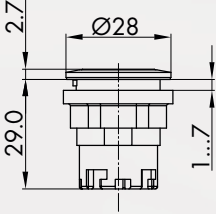

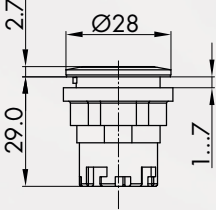
Type

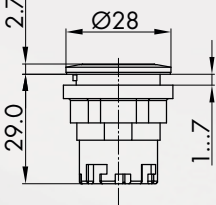
 <p>IP65 IP67 6mm Sun Lightning</p>	 <p>2.7 Ø28 29.0 1.7</p>	<p>Pushbutton Head, silver-coloured</p> <p>suitable contact blocks DS DT ET M</p> <p>front bezel silver-coloured</p>	<p>JRMT</p>
--	---	---	-------------

 <p>IP65 IP67 6mm Sun Lightning</p>	 <p>2.7 Ø28 29.0 1.7</p>	<p>Pushbutton Head, charcoal</p> <p>suitable contact blocks DS DT ET M</p> <p>front bezel charcoal</p>	<p>JRT</p>
--	---	---	------------

 <p>IP65 IP67 6mm Sun Lightning</p>	 <p>2.7 Ø28 29.0 1.7</p>	<p>Pushbutton Head, maintained, silver-coloured</p> <p>suitable contact blocks DS DT ET M</p> <p>front bezel silver-coloured</p>	<p>JRMF</p>
---	--	---	-------------

 <p>IP65 IP67 6mm Sun Lightning</p>	 <p>2.7 Ø28 29.0 1.7</p>	<p>Pushbutton Head, maintained, charcoal</p> <p>suitable contact blocks DS DT ET M</p> <p>front bezel charcoal</p>	<p>JRF</p>
--	---	---	------------

	<p>Flat Lens, transparent</p>	<p>colour</p> <ul style="list-style-type: none"> blue  yellow  green  clear  red  opalwhite  	<ul style="list-style-type: none"> T22RRBL T22RRGB T22RRGN T22RRKL T22RRRT T22RRWS
---	--------------------------------------	--	--

	<p>Flat Lens, non-transparent</p>	<p>colour</p> <ul style="list-style-type: none"> blue  yellow  green  black  red  white  silver-coloured  	<ul style="list-style-type: none"> T22RRGBL T22RRGGB T22RRGGN T22RRGSW T22RRGRT T22RRGWS T22RRGM
---	--	---	---

About Us

Control Units
Actuators

Panel Mount Jacks

Bus Technology

Enclosures

Terminal Blocks



























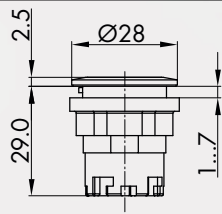







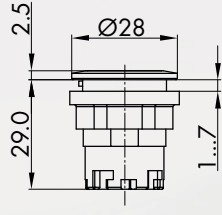

Pedal Switches

Limit Switches

Type Index

Pushbutton Heads

Lenses and nameplates to be ordered separately

Illustration	Dimensions	Description	Type
		High Lens, transparent colour blue  yellow  green  clear  red  opalwhite 	T22HRRBL T22HRRGB T22HRRGN T22HRRKL T22HRRRT T22HRRWS
		Blank Nameplate	BSRRU
		Nameplate with standard imprint Please specify index number (see nameplates on page 404 in the product catalogue)	BSRR...
		Nameplate with special imprint according to customer's specification	BSRRB
    		Pushbutton Head with ring illumination, silver-coloured incl. lens suitable contact blocks      front bezel silver-coloured 	JRMLTR
    		Pushbutton Head with ring illumination and laser printing, silver-coloured incl. lens, with laser printing, standard imprints see nameplates on page 404 in the product catalogue (please specify index number), special inscription on request suitable contact blocks      front bezel silver-coloured 	JRMLRL...
		Sealing Cap made of silicone rubber, down to -50°C	TK28S

About Us

Control Units

Panel Mount Jacks

Bus Technology

Enclosures

Terminal Blocks

Pedal Switches

Limit Switches

Type Index

→ Actuators

Emergency-Stop Head

About Us

Control Units

Actuators

Panel Mount Jacks

Bus Technology

Enclosures

Terminal Blocks

Pedal Switches

Limit Switches

Type Index

Illustration

Dimensions

Description

Type

IP65
IP67
IP69K

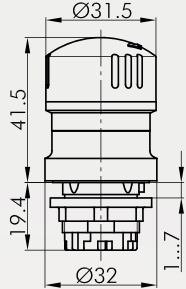

Emergency-stop Head

Foolproof	Yes
Switching position indicator	Yes
Permissive function	No
Anti-lock collar	No
Release	twist right or left
Standard	EN 60947-5-1, EN 60947-5-5, EN ISO 13850



suitable contact blocks

ASI DS DT ET M

mushroom head

red



front bezel

yellow



QRUV











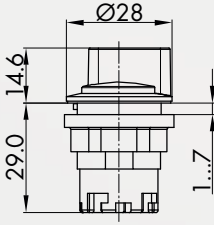

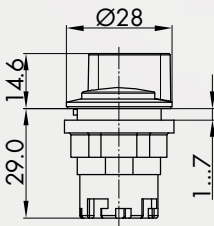

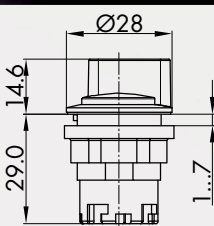

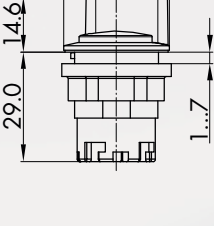
For further emergency-stops, please refer to the chapter "Emergency-stop Head" starting on page 366 in the product catalogue

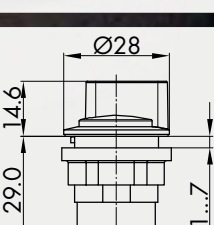
The emergency-stop heads can also be supplied as latching mushroom heads with mushrooms in different colours.

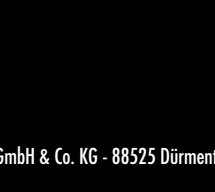
Selector Switches (momentary/maintained)

I = Switching position
> = Spring return

Illustration	Dimensions	Description	Type
		Selector Head, maintained, silver-coloured suitable contact blocks DS DT ET M	
		front bezel silver-coloured	JRMWA
		suitable contact blocks DT M	
		front bezel silver-coloured	JRMWB
		suitable contact blocks DS DT ET M	
		front bezel silver-coloured	JRMSTA
		suitable contact blocks DT M	
		front bezel silver-coloured	JRMSTB
		suitable contact blocks DT M	
		front bezel silver-coloured	JRMWC
		suitable contact blocks DS DT ET M	
		front bezel silver-coloured	JRMWAL
		suitable contact blocks DS DT M	
		front bezel silver-coloured	JRMWBL
		suitable contact blocks DS DT M	
		front bezel silver-coloured	JRMWCL

About Us

Control Units

Panel Mount Jacks

Bus Technology

Enclosures

Terminal Blocks

Pedal Switches

Limit Switches

Type Index

→ Actuators

Selector Switches (momentary/maintained)

I = Switching position
> = Spring return

Illustration

Dimensions

Description

Type

IP65

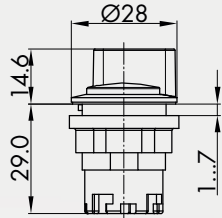

Selector Head, maintained, charcoal

suitable contact blocks

 DS DT ET M

front bezel

charcoal



JRWA

suitable contact blocks

DT M

front bezel

charcoal



JRWB

IP65

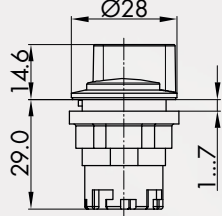

Selector Head, momentary, charcoal

suitable contact blocks

 DS DT ET M

front bezel

charcoal

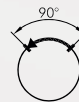

JRSTA

suitable contact blocks

DT M

front bezel

charcoal



JRSTB

IP65

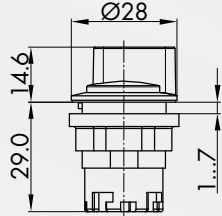

Selector Head, left maintained, right momentary, charcoal

suitable contact blocks

DT M

front bezel

charcoal



JRWC

IP65

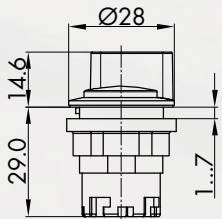

Illuminated Selector Head, maintained, charcoal

inclusive four small transparent colour plates in red, yellow, green and blue

suitable contact blocks

 DS DT ET M

front bezel

charcoal



JRWAL

suitable contact blocks

DS DT M

front bezel

charcoal



JRWBL

IP65

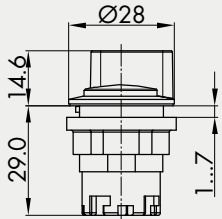

Illuminated Selector Head, left maintained, right momentary, charcoal

inclusive four small transparent colour plates in red, yellow, green and blue

suitable contact blocks

DS DT M

front bezel

charcoal



JRWCL

Key Switches (momentary/maintained)

- I = Switching position
- > = Spring return
- O = Key removable position

Illustration

Dimensions

Description

Type

IP65

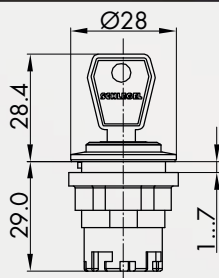

Key Actuator Head, maintained, silver-coloured

including two keys
other lock types on request

suitable contact blocks

DS DT M

front bezel silver-coloured

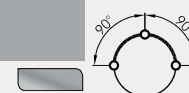

JRMSSA12E

suitable contact blocks

DS DT M

front bezel silver-coloured



JRMSSA13E

suitable contact blocks

DS DT ET M

front bezel silver-coloured



JRMSSA14E

suitable contact blocks

DS DT ET M

front bezel silver-coloured



JRMSSA15E

suitable contact blocks

DS DT ET M

front bezel silver-coloured



JRMSSA17E

suitable contact blocks

DS DT ET M

front bezel silver-coloured



JRMSSA18E

suitable contact blocks

DS DT ET M

front bezel silver-coloured



JRMSSA19E

IP65

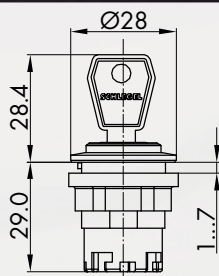

Key Actuator Head, momentary, silver-coloured

including two keys
other lock types on request

suitable contact blocks

DS DT M

front bezel silver-coloured



JRMSSA23E

suitable contact blocks

DS DT ET M

front bezel silver-coloured



JRMSSA28E

Ø 22,3 mm

Key Switches (momentary/maintained)

- I = Switching position
- > = Spring return
- O = Key removable position

Illustration

Dimensions

Description

Type

IP65

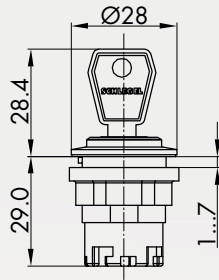

Key Actuator Head, left maintained, right momentary, silver-coloured

including two keys
other lock types on request

suitable contact blocks

DS DT M

front bezel

silver-coloured



JRMSSA24E

suitable contact blocks

DS DT M

front bezel

silver-coloured

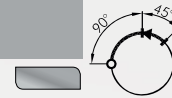

JRMSSA25E

About Us

Control Units
Actuators

Panel Mount locks

Bus Technology

Enclosures

Terminal Blocks

Pedal Switches

Limit Switches

Type Index

Key Switches (momentary/maintained)

- I = Switching position
- > = Spring return
- O = Key removable position

Illustration

Dimensions

Description

Type

IP65

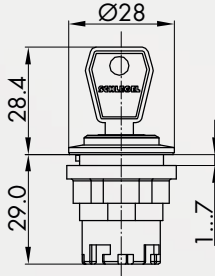

Key Actuator Head, maintained, charcoal

including two keys
other lock types on request

suitable contact blocks DS DT M				
front bezel	charcoal			JRSSA12E
suitable contact blocks DS DT M				
front bezel	charcoal			JRSSA13E
suitable contact blocks Wi DS DT ET M				
front bezel	charcoal			JRSSA14E
suitable contact blocks Wi DS DT ET M				
front bezel	charcoal			JRSSA15E
suitable contact blocks Wi DS DT ET M				
front bezel	charcoal			JRSSA17E
suitable contact blocks Wi DS DT ET M				
front bezel	charcoal			JRSSA18E
suitable contact blocks Wi DS DT ET M				
front bezel	charcoal			JRSSA19E

IP65

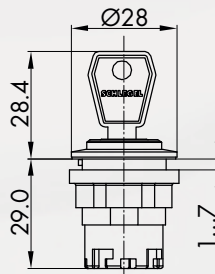

Key Actuator Head, momentary, charcoal

including two keys
other lock types on request

suitable contact blocks DS DT M				
front bezel	charcoal			JRSSA23E
suitable contact blocks Wi DS DT ET M				
front bezel	charcoal			JRSSA28E

About Us

Control Units

→ Actuators

Panel Mount Jacks

Bus Technology

Enclosures

Terminal Blocks

Pedal Switches

Limit Switches

Type Index

Key Switches (momentary/maintained)

- I = Switching position
- > = Spring return
- O = Key removable position

Illustration

Dimensions

Description

Type

IP65

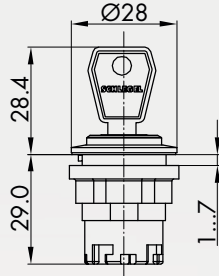

Key Actuator Head, left maintained, right momentary, charcoal

including two keys
other lock types on request

suitable contact blocks

DS DT M

front bezel charcoal



JRSSA24E

suitable contact blocks

DS DT M

front bezel charcoal



JRSSA25E



Spare Key (standard)

standard spare key, specify key number for special locks

ESE845

Buzzer Panel Mount Jacks

Illustration

Dimensions

Description

Type

IP65

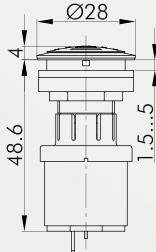

Buzzer, silver-coloured

operating voltage: 12 ... 24V AC/DC
operating current: max. 30mA
signal frequency: 3.5 +/- 0.5 Hz
volume: max. 85 db (10cm, 24V)
max. 80 db (10cm, 12V)
operating temperature: -20°C ... 60°C

front bezel

silver-coloured



RRJNSG+SG-24V

IP65

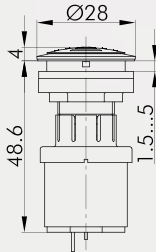

Interval Buzzer, silver-coloured

operating voltage: 12 ... 24V AC/DC
operating current: max. 30mA
signal frequency: 3.5 +/- 0.5 Hz
volume: max. 85 db (10cm, 24V)
max. 80 db (10cm, 12V)
interval: 1 s
operating temperature: -20°C ... 60°C

front bezel

silver-coloured



RRJNSG+SGI-24V

**For panel mount jacks,
please refer to page 552 in the product catalogue**



IP65

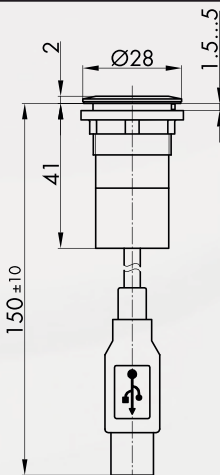

WiFi adapter to USB

Specification: 802.11n-norm and downward compatible to the IEEE802.g/B standards supports 64/128-bit WEP, WPA and WPA2 encoding

System requirements: Windows XP, Vista, 7, 8, 8.1, 10, Mac OS X and Linux

Connection: USB-2.0 cable (150cm)

colour

silver-coloured



RRJ_WLU_01

IP65

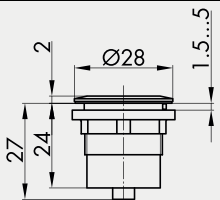

WiFi antenna

Standard: IEEE 802.11 ac/a/b/g/n
Connection: SMA end launch jack acc. to IEC 60169-15

colour

silver-coloured



RRJ_WLA_01

Ø 22,3 mm

Pilot Light

Lenses and nameplates to be ordered separately

Illustration

Dimensions

Description

Type

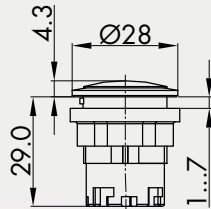

Pilot Light Head, silver-coloured

suitable contact blocks

DS DT ET M

front bezel

silver-coloured



JRMN

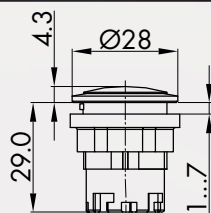

Pilot Light Head, charcoal

suitable contact blocks

DS DT ET M

front bezel

charcoal



JRN



Lens

colour

blue



K22RRBL

yellow



K22RRGB

green



K22RRGN

clear



K22RRKL

red



K22RRRT

opalwhite



K22RRWS



Blank Nameplate

BSRRU



Nameplate with standard imprint

BSRR...

Please specify index number (see nameplates on page 404 in the product catalogue)



Nameplate with special imprint

BSRRB

according to customer's specification

About Us

Control Units

Panel Mount Jacks

Bus Technology

Enclosures









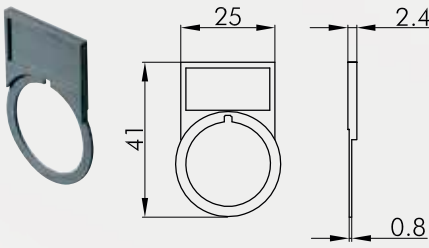

Terminal Blocks

Pedal Switches

Limit Switches

Type Index

Accessories for Control Units

Illustration	Dimensions	Description	Type
		Mounting Tool with torque limitation for the series QUARTEX-R(-JUWEL), KOMBITAST-R-JUWEL, RONDEX, RONDEX-M, RONDEX-JUWEL, RVA, DUX-Basic, SHORTRON, jacks of the ranges RONTRON-R/-Q-JUWEL	S22
		Mounting Tool Adapter with 1/4" connections for mounting tools S16 and S22	SRA
		External Nameplate Holder for outside marking of the actuators of the RX-JUWEL, RONDEX-JUWEL series, accepts self-adhesive nameplates	
		colour charcoal  silver-coloured 	RXJABT RXJMABT
		Self-adhesive Nameplate laser-printed	BZ16L
		Inscription according to customer's specification Dimensions: 22 x 11 mm	
		Self-adhesive Nameplate blank	BZ16U
		Dimensions: 22 x 11 mm	
		Self-adhesive Nameplate with standard imprint	BZ16B...
		Please specify index no. (see nameplates on page 404 in the product catalogue) Dimensions: 22 x 11 mm	
		Yellow Nameplate self-adhesive PVC foil printing on request outer dia. 75 mm for mounting dia. 22 mm	
		colour yellow 	NAS_22
		Yellow Nameplate with quadrilingual imprint self-adhesive PVC foil outer dia. 75 mm for mounting dia. 22 mm	
		colour yellow 	NAS_22_548

About Us

Control Units
→ Actuators

Panel Mount Jacks

Bus Technology

Enclosures

Terminal Blocks

Pedal Switches

Limit Switches

Type Index

Ø 22,3 mm

Accessories for Control Units

Illustration

Dimensions

Description

Type

IP40



Lead-sealable Protective Lid

from -30 °C to +70°C

colour

transparent



KDP22RR

IP65
IP67



Lead-sealable, robust Protective Lid

Lifetime: >100,000 cycles

colour

transparent
black



KDPR22RR

KDPR22RR_SW



Universal Lens Remover

USK

IP65



Dummy

to close unused mounting apertures

colour

silver-coloured
charcoal



BVJRM

BVJR

About Us

Control Units

Panel Mount Jacks

Bus Technology

Enclosures

Terminal Blocks

Pedal Switches

Limit Switches

Type Index



Georg Schlegel GmbH & Co. KG
Kapellenweg 4
88525 Dürmentingen / Germany
Tel.: +49 (0)7371 / 502-0
Fax: +49 (0)7371 / 502 49
E-Mail: info@schlegel.biz
www.schlegel.biz



Subsidiaries:



Schlegel Elektrokontakt GmbH
Schönbachstr. 93
04299 Leipzig / **Germany**
Tel.: +49 (0)341 / 8 68 72-0
Fax: +49 (0)341 / 8 68 72 33
E-Mail: leipzig@schlegel.biz
www.schlegel.biz



Georg Schlegel Vertriebs Ges.mbH
Samuel Morse-Straße 7
2700 Wiener Neustadt / **Austria**
Tel.: +43 (0)2622 / 81313
Fax: +43 (0)2622 / 81313-19
E-Mail: schlegel@schlegel.at
www.schlegel.at

